



RH800 & 2000 MAINTENANCE GUIDE





MENU

i
This is an interactive PDF. Click on an icon tile and navigate to a chapter of interest.



Legal & Safety



Rotary Heads



In-Line Filter



Pump Element

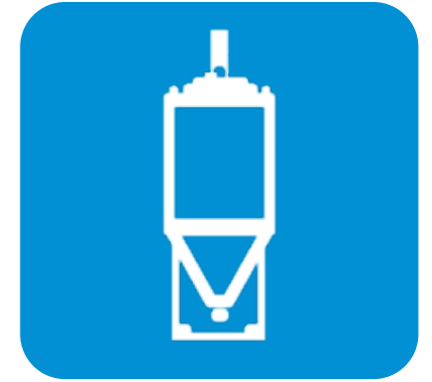

CBP Tanks



Drum & Frame



Garmotors



Control Panels



Troubleshooting



Pictograms

Users can advance or go back single pages by using quick navigation links shown below, right.

Users can navigate to the Menu by clicking on the Menu icon shown below, left.

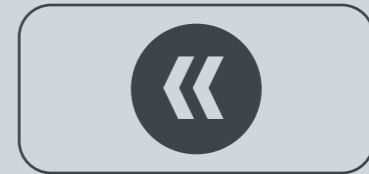



LEGAL & SAFETY

This manual contains technical information regarding Bayer SeedGrowth™ Equipment. Please read and understand these instructions completely before proceeding to install and operate the equipment. Bayer reserves the right to change specifications, models, components, or materials at any time without notice. For additional equipment information contact us at 1.800.634.6738. Please have this manual available when contacting Bayer.

Always use caution and common sense when working with any chemical. Read the product label and SDS carefully and follow their instructions exactly as described.

Optimal operating conditions for this piece of equipment requires an ambient temperature 32° F to +104° F (0° C to +40° C), relative humidity less than 90% (minimum condensation). Make necessary provisions to protect this piece of equipment against excessive dust, particles containing iron, moisture and against corrosive and explosive gases.

Our technical information is based on extensive testing and is, to the best of our current knowledge, true and accurate but given without warranty as the conditions of use and storage are beyond our control. Variables, such as humidity, temperature, change in seed size or variety and viscosity of chemical products can all affect the accuracy of the chemical application and seed coverage. To ensure the desired application rate and optimum seed coverage, check the calibration periodically throughout the day, and make adjustments as needed.

Any person who is involved in the installation or periodic maintenance of this equipment should be suitably skilled or instructed and supervised using a safe system of work. Isolate the treater before removing guards for maintenance.





EXPOSURE CONTROL

Always use caution and common sense when working with chemicals. Read the product label and SDS carefully and follow their instructions exactly as described. The following Personal Protective Equipment (PPE) recommendations and best practices help promote safe use in seed treatment.



Note: Exposure Control signs and labels conform to the requirements of ANSI Z535.4 or ISO 3864.



Wear protective clothing

Wear disposable or reusable coveralls with long sleeves.



Hand protection required

Wear chemical-resistant gloves.



Wear rubber boots

Wear chemical resistant rubber boots.



Labels

Label recommendations and directions for handling must be followed, including treatment procedure (use of sticker) as well as the safety requirements.



Treatment products

Keep products in a locked room that has been approved for crop protection products.



Wear a mask

Wear respiratory protection.



Eye protection required

Wear protective eyewear.



Calibration

Seed treatment equipment must be checked and calibrated regularly to ensure accurate and safe application.

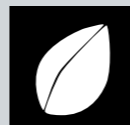

Clean seed

Use well cleaned seed to avoid creation of polluted dust that will contaminate the machine, treating facility, workers, farmers and the environment during sowing.

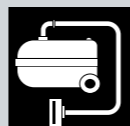

Cleaning

Use a vacuum to clean machines. Avoid using compressed air for cleaning.

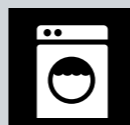

Laundry

Wash soiled reusable clothing separately. Workers must take a shower after each shift.



Empty containers

Non-returnable empty containers must be triple rinsed before they can be disposed. For others the recommendation of the producer must be followed.



Spillage

Spillage must be avoided; it must be thoroughly cleaned up to avoid contaminating the environment and waterways.



Maintenance

Keep machinery clean between treating sessions.





REFERENCE SYMBOLS

Symbols and signal words are used to identify the level of hazard and help avoid personal injury.



Note: Safety signs and labels conform to the requirements of ANSI Z535.4 or ISO 3864.



Shock Hazard

Alerts that dangerous voltage may be present.



Warning

Alerts that a hazard may cause serious injury or death.



Caution

Alerts that a hazard may cause minor or moderate injury.



Hand crush - moving parts

Alerts crushing is possible.



Pinch point

Keep hands away from pinch points.



Rotating shaft

Do not wear loose clothing around turning parts.



Disconnect

Disconnect to de-energize before opening.



Use guards

Keep guards in place. Do not remove during operation.



Lifting

Requires two people to safely lift an item.



Lift points

Requires the use of proper rigging and lifting techniques based on the lift plan.



Center of gravity

Indicates the center of gravity of the machine to help assist when rigging and lifting.



Tools

Required tools for installation and maintenance.



Parts

Required parts for installation and maintenance.



Tip

Calls attention to special information.



Note

Emphasizes general information worthy of attention.



Example

Provides a problem or exercise that illustrates a method or principle.





PICTOGRAMS

i

Each Signifier displayed here is specific to this User Manual.

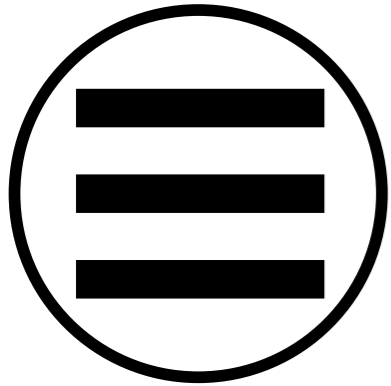

Menu



Previous



Advance

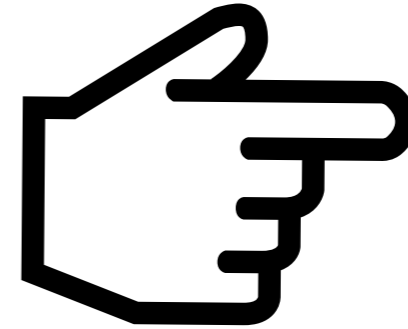

Cursor Hand

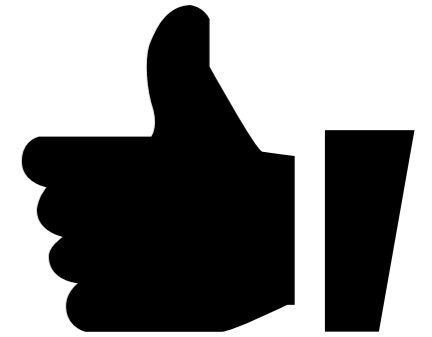

Like



Gearmotors



Rotary Heads



Drum & Frame



In-Line Filter



Control Panels



Troubleshooting



CBP Tank



Pump Element





ROTARY HEADS



Warning! Exercise extreme caution when working with chemicals! Wear proper PPE >>

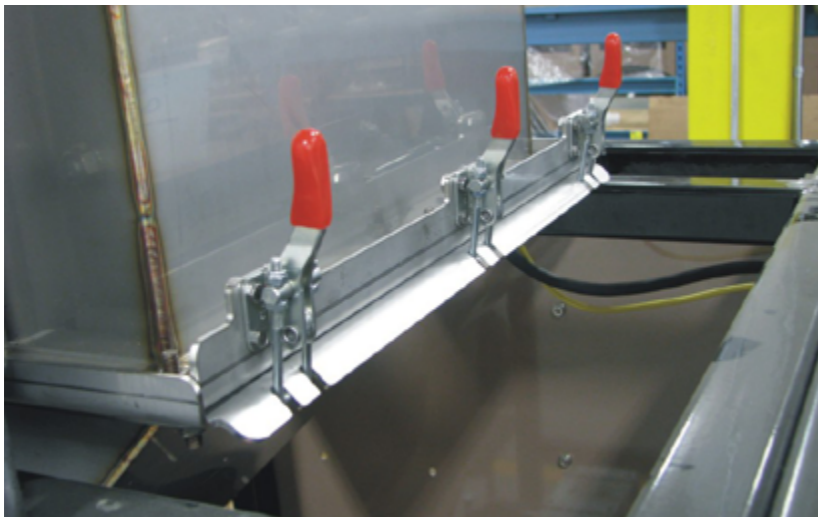

Seed Transition Quick Clean out

Step 1: Remove the Seed Transition.

- Place one hand on the transition and use the other to unlatch the three clamps holding the transition onto the bottom of the Atomizer section.



Step 2: Clean the Seed Transition.

- Use a rag to wipe down inside the Seed Transition and a putty knife to scrape any residue build-up.

Continued ➡





Note: Seed Wheel (Reducer) factory fill of Glygoyle 460 lubricant does not require changing after break-in and is satisfactory for the full service life of the reducer.



Step 3: Remove the atomizer with a wrench.

- Use a rag to thoroughly clean the atomizer and atomizer housing.
- This is recommended after each treating session, to avoid unnecessary chemical and seed buildup, as shown left.
- Replace the atomizer on the shaft.
- Push it up on the shaft until it touches the chemical tube, then back it off a little.
- Tighten the nut.

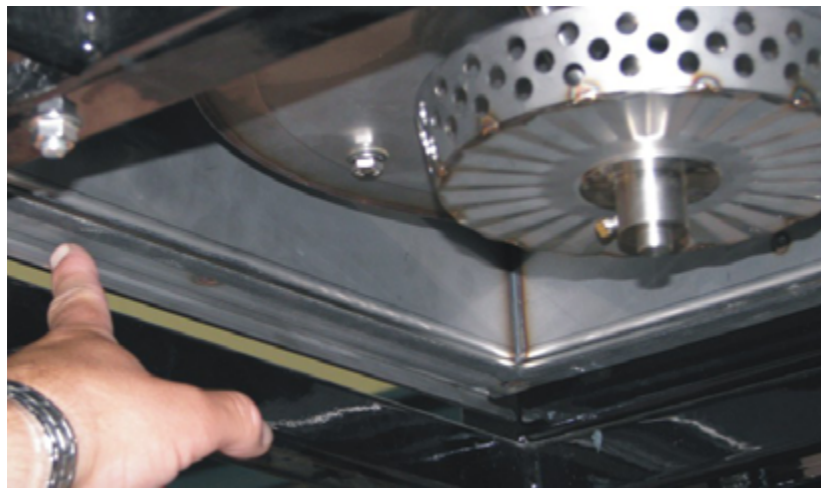

Step 4: Replace the clean Transition under the Atomizer Housing.

- Align the Transition to the back lip of the Housing and ensure each clamp is in line with the grooves on the transition.
- Close each Clamp to securely fasten the transition in place.





CBP TANK IN-LINE FILTER



Warning! Exercise extreme caution when working with chemicals! Wear proper PPE >>



Tank In-line Filter

Check filters periodically for clogging issues.

Step 1: Turn the Tank Valve in **RINSE** mode.

Failure to clean the treating system (including all accessories) properly, or failure to completely drain all liquid chemicals from the Pump and Treatment lines after use, may cause damage to the equipment and void the warranty!

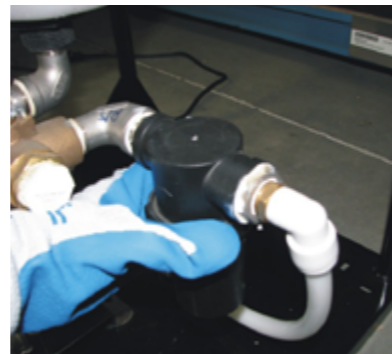

Step 2: Place a drip pan or bucket beneath the filter...

- Unscrew the Basket from the cap.
- Remove the filter from the basket and clean thoroughly.
- Ensure the gasket is seated correctly within the groove.
- Replace the filter inside the Filter basket and **HAND TIGHTEN** the Basket onto the Cap.



PUMP ELEMENT CHANGE



Warning! Exercise extreme caution when working with chemicals! Wear proper PPE >>



Changing the Pump Element

Step 1: Turn the Tank Valve in **RINSE** mode.



Warning! Leaving the pump element in the pump head in the closed position over a duration of time will permanently leave a flat spot on the pump element.

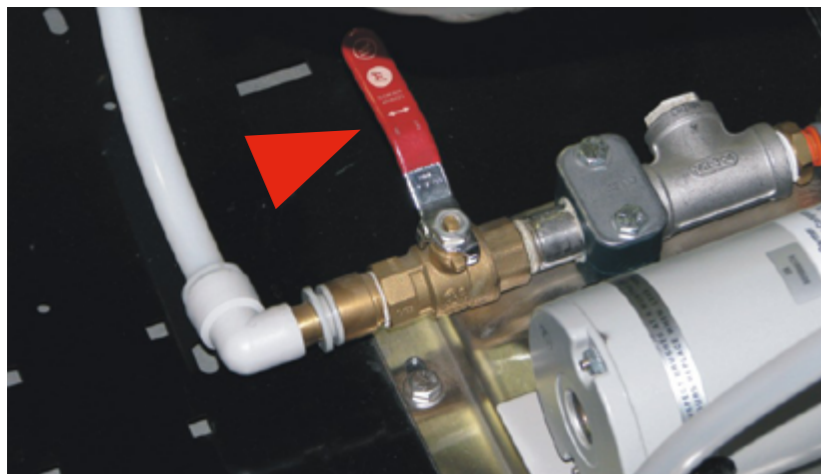

Step 2: **CLOSE** the Pump Flow Valve.

Continued ⇌



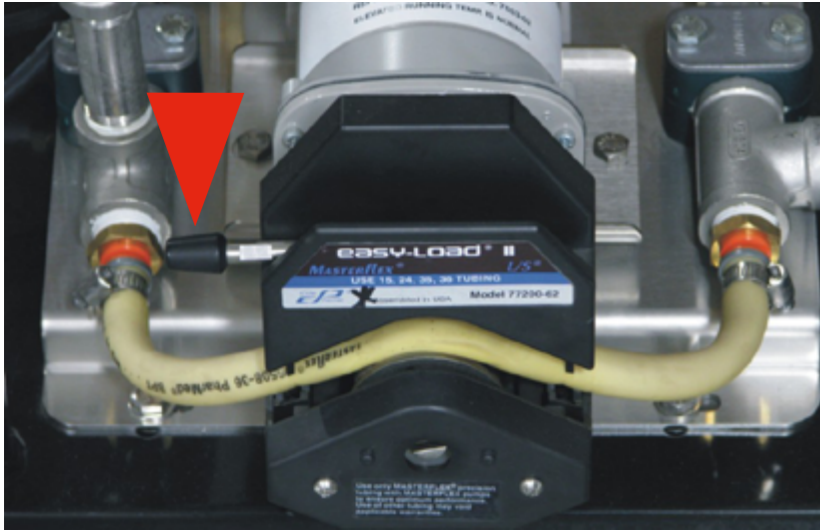

Step 3: Use the handle to **OPEN** the pump head.

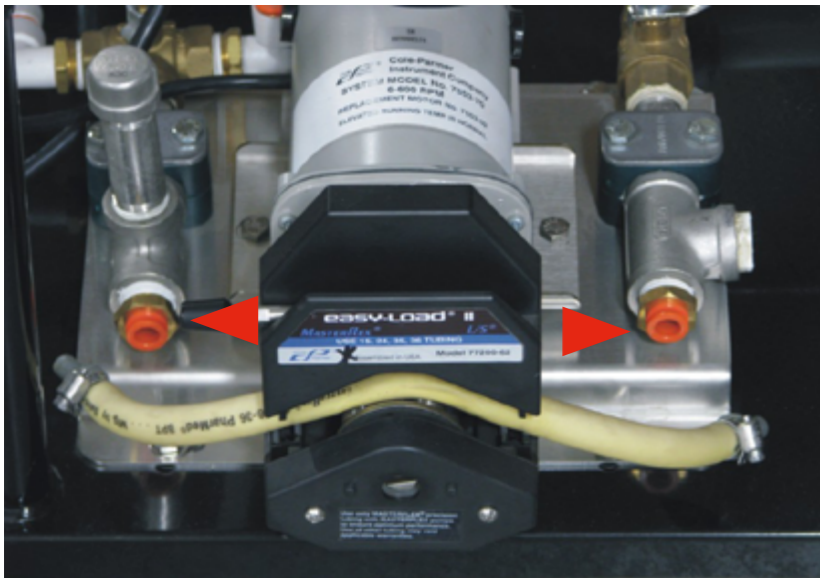

Step 4: Push each orange press lock fitting to release and remove the element from the pump head.

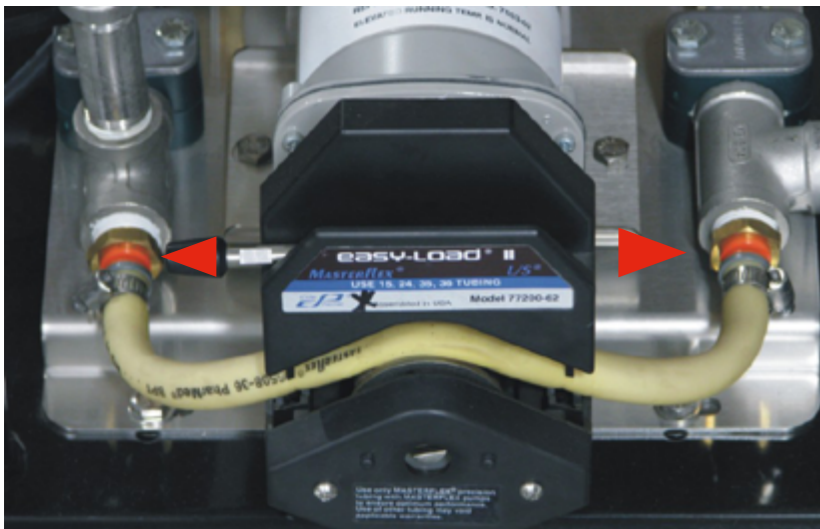

Step 5: Insert the new element assembly into each of the orange pump fittings.

Continued ➡





Step 6: Ensure the Pump Element fits properly onto the Pump Roller and under each Clip, as shown. Failure to properly align the Element may cause Pump failure!



Step 7: Use the handle to **CLOSE** the pump head.

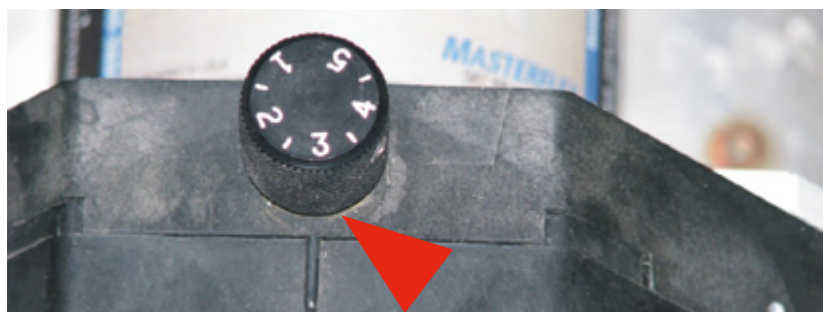

I/P Pump Only

Set the Pump Head Tension Adjustment Knob to #3.





CBP TANK RINSE



Warning! Exercise extreme caution when working with chemicals! Wear proper PPE >>

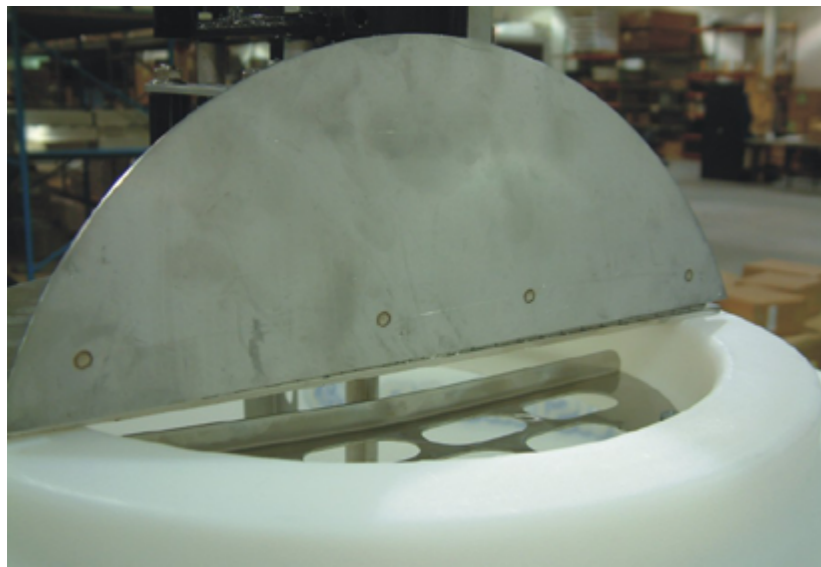

Tank Rinse

Step 1: Fill the Tank with clean water.



Step 2: Ensure Tank valves are in the **TREAT** mode position.

Continued ➡



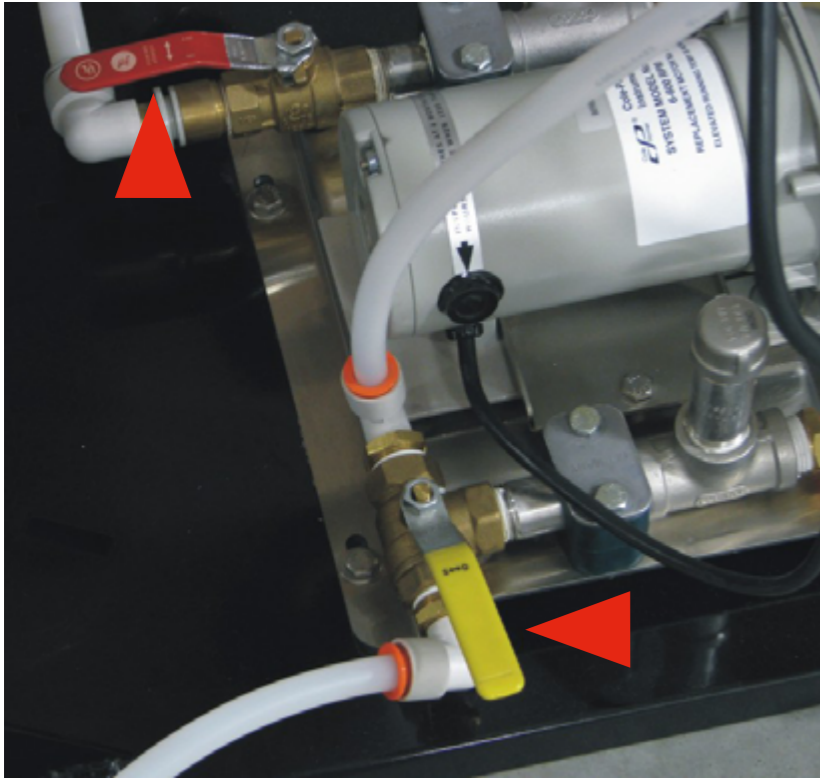

Step 3: Ensure the Pump Flow and Recirculation Valves are in the **TREAT** mode position.

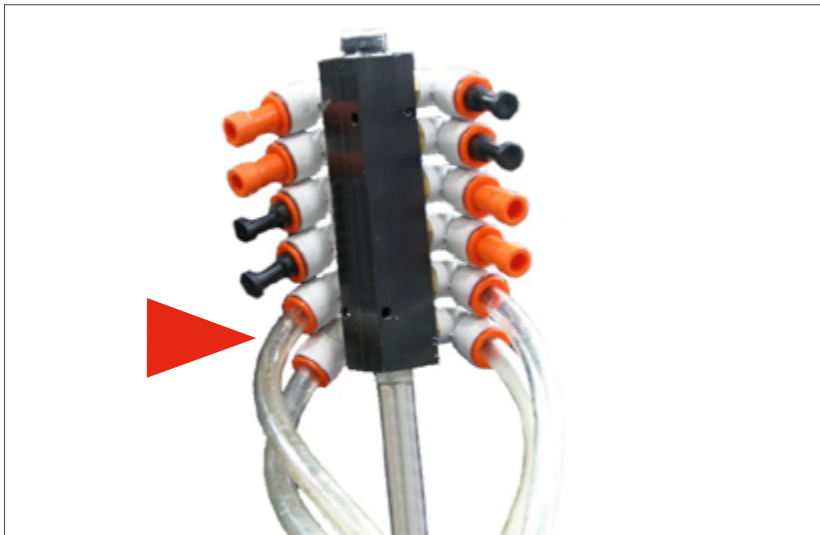

Step 4: Push the PUMP #1 orange fitting to disconnect the treatment line from the Chemical Inlet Assembly (on the Treating Head Assembly).

Continued ➔





Step 5: Hold the Treatment line in a 5 gallon pail. May need a larger container if all 60 gallons of water will be used to rinse the Tank. **DO NOT RUN RINSE WATER DOWN THE DRAIN!**



Step 6: Turn PUMP #1 Switch to **AUTO**.

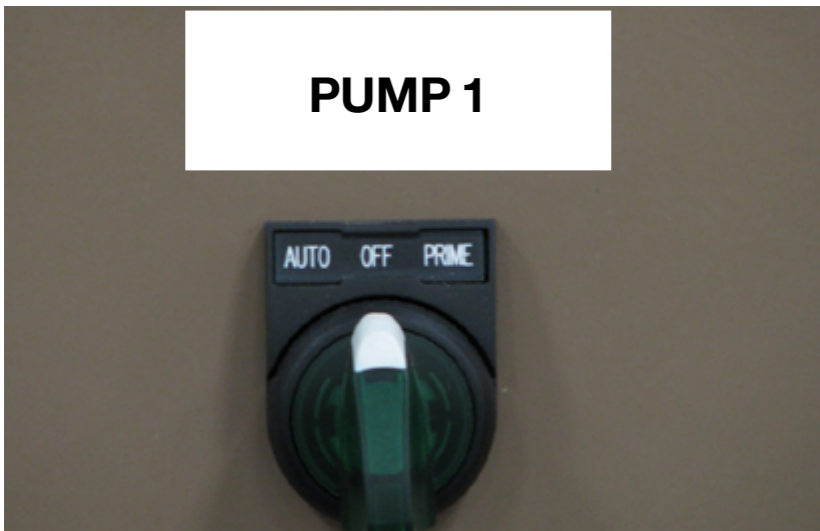

Step 7: Allow the Pump to run and rinse out the Supply Tank, Pump Element and Treatment Line until the 5 gallon bucket is full. Turn **OFF** Pump 1 Switch. Repeat steps 1-7 for each pump used (1-4).

Continued ➡





Warning! The rinse water (gray water) in the pail may be saved and used with the next slurry mix or disposed of properly, according to state and local regulations.

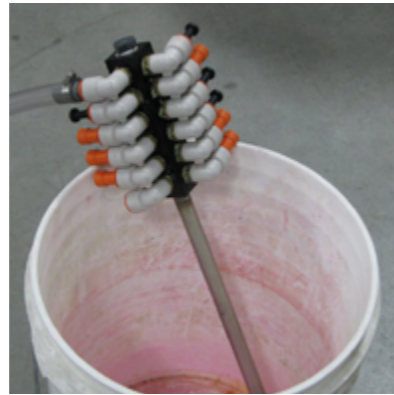
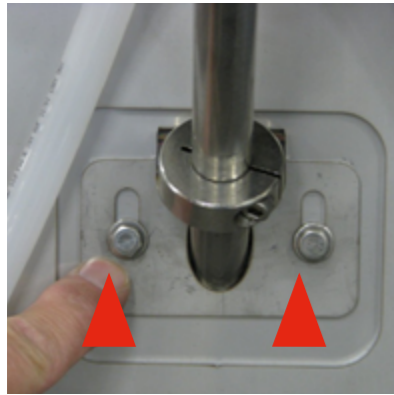

Chemical Inlet Assembly

Step 1: Repeat steps 1-3 on page 7. Remove the 2 screws that hold the Chemical Inlet on the Treating Head. Place the Chemical Inlet Assembly connected to the Treatment Line in a 5 gallon pail, as shown. Turn the PUMP 1 Switch to **AUTO** and allow the Pump to run until the 5 gallon bucket is full. Turn **OFF** Pump 1 Switch.

Continued ➞



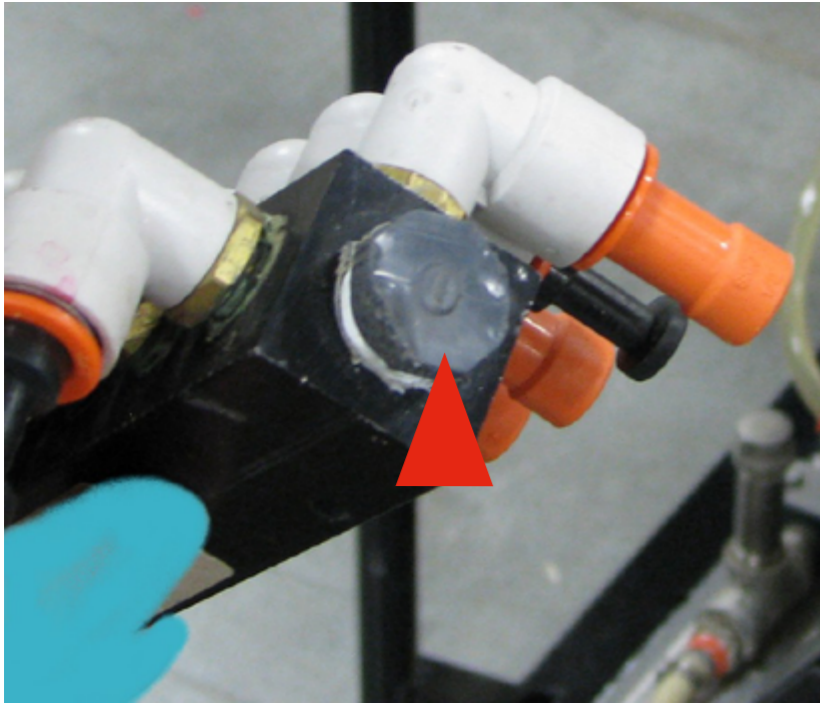

Step 2: Use a wrench to remove the nut on the end of the Chemical Inlet Assembly. Use a tube brush to thoroughly clean the inside of the Chemical Inlet Assembly. Replace the nut and tighten securely.

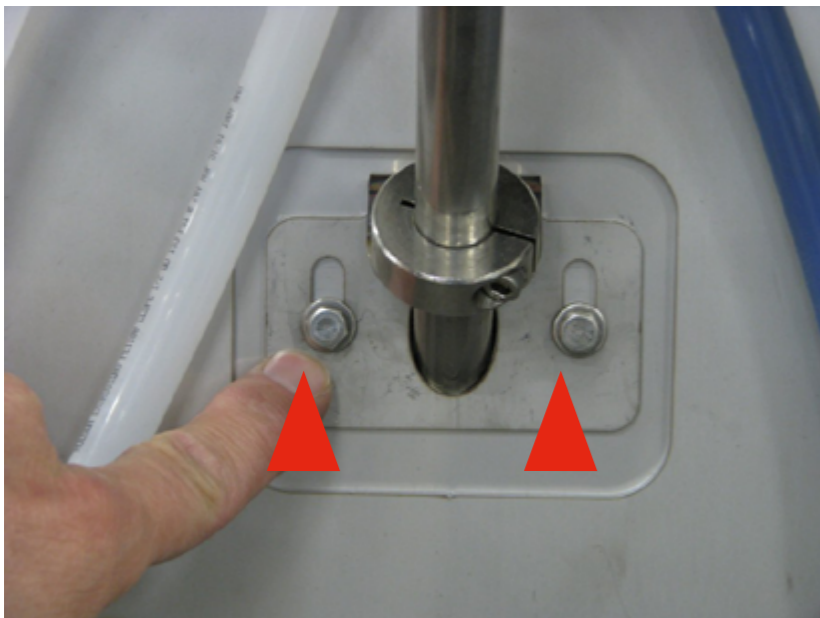

Step 3: Connect the Chemical Inlet Assembly back onto the Treating Head Assembly and tighten securely.





DRUM & FRAME



Grease Zerk

Step 1: Remove Drum Guards from both sides of the Drum.

- Use a 7/16 wrench to loosen the four bolts that hold the Drum Guard in place.



Step 2: Use a grease gun to lubricate each bearing zerk.

- There are nine pillow block bearings, five on the drive shaft side and four on the idler side.

Continued ➞

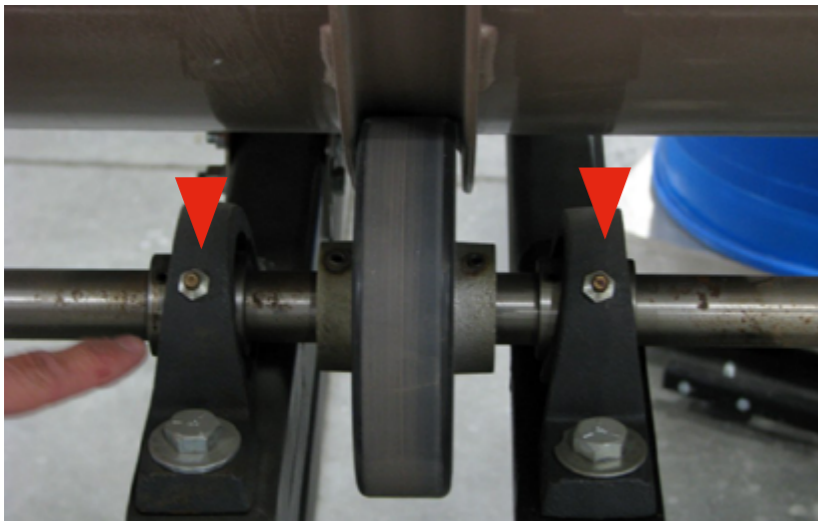



Step 3: Align the drum guard.

- Align the drum guard properly with the channel in the middle of the drum guard groove.



Step 4: Fasten Drum Guards.

- Fasten the Drum Guards in place and tighten securely.

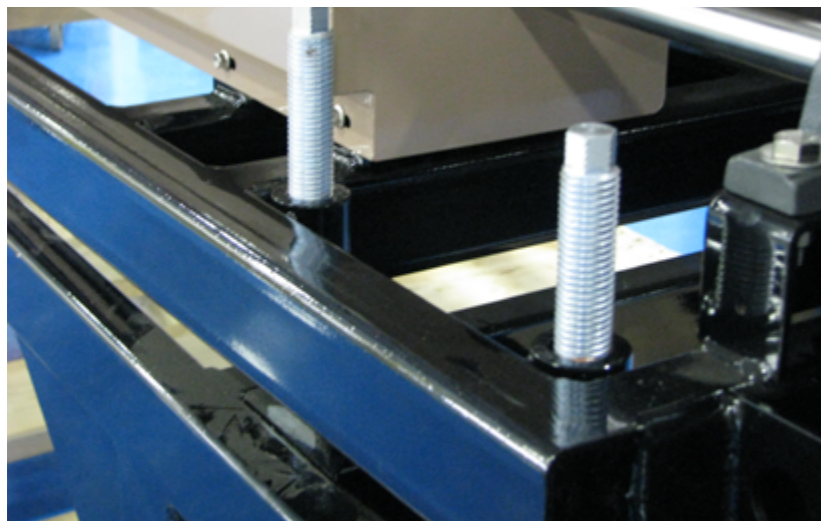

Drum Clean-out

Step 1: Use a wrench (on all thread bolt 3/4-10 SQ Nut) to lower the Drum angle to its most flat position.

Step 2: Fill the Drum with hot water.

Step 3: Run the VFD Drum Drive **FORWARD** for 30 minutes or so to clean the drum to the metal.

Step 4: An option is to add discard seed and letting that mix either with or without the hot water to clean the drum to the metal.

Step 5: Dispose of water and seed responsibly, according to state and local regulations. **DO NOT RUN RINSE WATER DOWN THE DRAIN!**



GEARMOTORS



Warning! The gear motor has been tested and adjusted at the factory. Dismantling or replacement of components must be done by the manufacturer to maintain the warranty!



Required maintenance tools

- 9/16" Wrenches (2)
- 6mm Allen Wrench
- 8mm Allen Wrench
- Oil Pan

Bevel Helical Gear Motor

After 100 hours of the initial operation of the Gear Motor, the housing should be thoroughly drained. After the initial break-in, the oil should be changed every six months or 2,500 operating hours (whichever comes first).

Lubrication - Standard (mineral): CLP 460

- Suitable for ambient temperatures from 32° to 104° F
- Life is 16,000 hours or three years when operating temperatures are between 158° and 176° F

Additional lubricants available upon request - Synthetic: GH6-680

- Extended temperature range -32° to 122° F

Food Grade: CLP-H1220

- Registered USDA-H1

Biodegradable: CLP-E320

- Water pollution class O

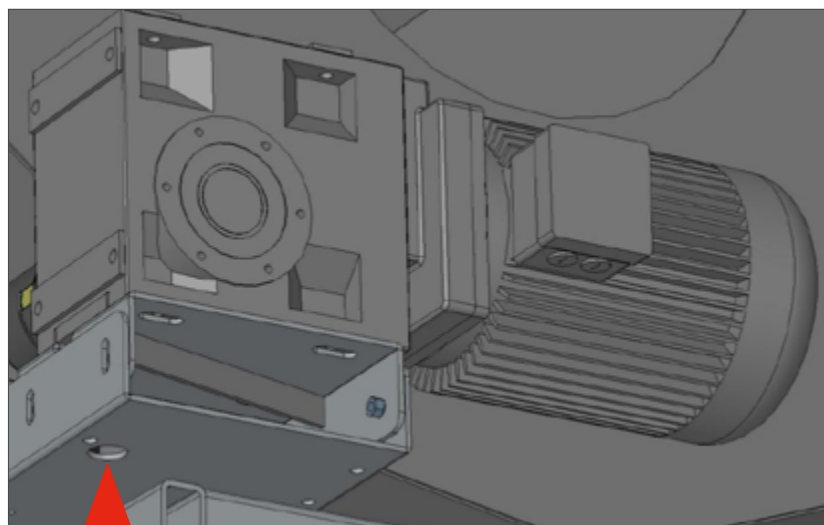

OIL DRAIN PLUG ACCESS HOLE

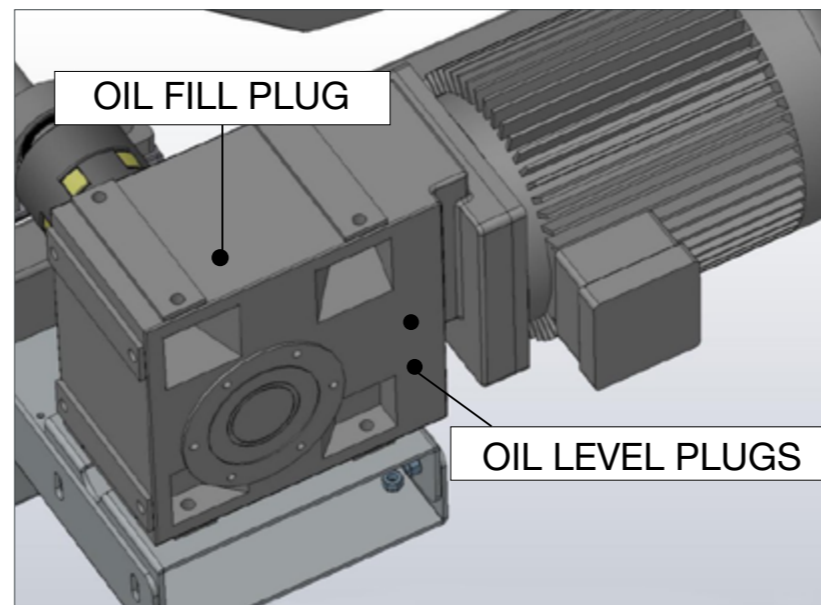

OIL FILL PLUG

OIL LEVEL PLUGS

THOROUGHLY DRAIN OIL WHILE IT IS WARM

Step 1: Use a 6mm Allen Wrench to remove the oil drain plug, located on the bottom of the Gear Motor. An access hole is provided on the Motor Mount to gain access to the oil drain plug without having to remove the entire Gear Motor. Drain thoroughly, then replace the oil drain plug.

Step 2: Use an 8mm Allen Wrench to remove both the fill and oil level plugs, located on the top and side of the Gear Motor. Fill the Gear Motor with new Standard (mineral): CLP 460 motor lubricant until oil comes out of the oil level plug on the side of the Gear Motor. Do not mix compounded oil and synthetic oil in the Gear Motor!

Step 3: Use an 8mm Allen Wrench to replace both the fill and oil level plugs. Tighten snug and secure.





CONTROL PANEL



Control Panel

Periodically remove, inspect and clean out air filters.

- Grasp the top of the filter frame and pull away from the panel, as shown.
- Remove the filter and clean with a vacuum cleaner or replace the filter.
- Repeat for air filter on the other top side of Controller.





TROUBLESHOOTING

Symptom

Seed wheel physically won't turn in Jog Mode, but speed display shows RPM ramping up normally

Seed wheel physically turns in Jog Mode, but not in Auto Mode

Pump switches light in Prime Mode, but not in Auto Mode even though the seed wheel is running

Pump switches don't light in either Prime Mode or Auto Mode

Pump switches light but pump don't physically run

Seed wheel runs too long / too short at end of batch, when seed falls off sensor

Potential Fixes

1. Verify display doesn't flash any error codes, or else note the error code and call tech support
2. Check twist-lock connection on bottom of seed wheel control

3. Verify Seed wheel isn't physically jammed: Unplug SW Control, then...
 - Open hinged side covers to do visual check for foreign objects lodged in seedwheel
 - Remove plastic cap on top of seed wheel motor and manually rotate motors-shaft to verify seed wheel is turning freely

1. Verify seed is present above seed wheel and covering sensor

Note: Sensor indicator-light should be lit when seed is present

1. Verify treater switch in "On" position (atomizer running)
2. Verify both breakers are On/Up inside the control

1. Verify Panel has power by turning on "Treater" switch which should run the atomizer motor and light the treater switch

2. Verify the (4) pump-breakers are in the On/Up position inside the control

1. Verify that each pump is plugged into the matching cord from the pump control and not crisscrossed
2. Verify Fwd/Rev switch, on pump speed control, is in "Fwd" position & speed is appropriately set

Verify timer setting inside seed wheel control:

- The timer is about 4in tall and 3/4in wide, with two small screwdriver size dials
- The lower dial adjusts the # of seconds that the seed wheel will run after the seed falls off the seed sensor ↻



Symptom

Pumps are running, but little or no chemical is flowing

Atomizer motor not running when “Treater Switch” is ON and indicator light is ON

Drum motor doesn't turn when start button on Drum drive is pressed

Pump calibration seems inconsistent when running back-to-back calibration checks

Potential Fixes

1. Verify pump speed is still set correctly from last calibration and hasn't been bumped
2. Run the pump in reverse: Does chemical flow better in reverse?

Yes: Clean Filter Basket

No: I/P Pump: Check occlusion adjustment on pump head (normally set between 3-5)

No: All Pumps: Check valve positions, filter, chemical line, pump element and treater inlet manifold for blockages

1. Verify the twist-lock connection on the 4-pump control labeled “Treater” is properly connected to the atomizer motor cord

2. If the atomizer motor has been sitting in storage, the brushes on the motor may be corroded and thus not making good contact

With control power unplugged...

- Remove the seed transition to the drum, to reveal the atomizer wheel
- Manually spin the atomizer wheel a few turns to break loose any corrosion
- Re-apply power and verify the atomizer motor starts/stops appropriately

1. Verify the twist-lock cord connection on Drum drive, labeled “Drum Motor” is properly connected to the Drum motor cord

2. If error codes are displayed before or after pressing start, write down the error codes and contact Bayer technical support

Verify the drain valve under the calibration beaker is closing completely

Note: This type of valve can at times feel closed when in fact it's not quite closed

- Firmly close valve to make sure it's fully seated closed





Bayer

Crop Science Division
1451 Dean Lakes Trail
Shakopee, MN 5379
USA

Telephone

+1-952-445-6868

Toll free:

+1-855-363-3152

Visit us on:

www.seedgrowth.bayer.com

Bayer™ and the Bayer Cross™ are registered trademarks of Bayer.

RHMAINTENANCE20211022

