



FLOW METER KIT #80495684





MENU

i
This is an interactive PDF. Click on an icon tile and navigate to a chapter of interest.



Legal & Safety



System Diagram



Installation

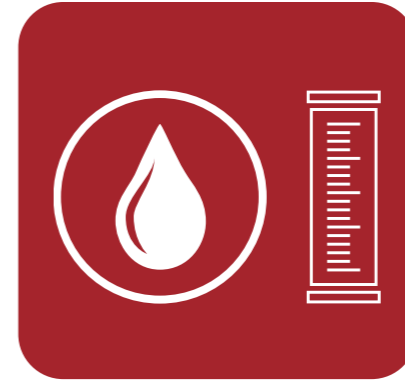

Calibration



Operation



Maintenance



Pictograms

Users can advance or go back single pages by using quick navigation links shown below, right.

Users can navigate to the Menu by clicking on the Menu icon shown below, left.





LEGAL & SAFETY

This manual contains technical information regarding Bayer SeedGrowth™ Equipment. Please read and understand these instructions completely before proceeding to install and operate the equipment. Bayer reserves the right to change specifications, models, components, or materials at any time without notice. For additional equipment information contact us at 1.800.634.6738. Please have this manual available when contacting Bayer.

Always use caution and common sense when working with any chemical. Read the product label and SDS carefully and follow their instructions exactly as described.

Optimal operating conditions for this piece of equipment requires an ambient temperature 32° F to +104° F (0° C to +40° C), relative humidity less than 90% (minimum condensation). Make necessary provisions to protect this piece of equipment against excessive dust, particles containing iron, moisture and against corrosive and explosive gases.

Our technical information is based on extensive testing and is, to the best of our current knowledge, true and accurate but given without warranty as the conditions of use and storage are beyond our control. Variables, such as humidity, temperature, change in seed size or variety and viscosity of chemical products can all affect the accuracy of the chemical application and seed coverage. To ensure the desired application rate and optimum seed coverage, check the calibration periodically throughout the day, and make adjustments as needed.

Any person who is involved in the installation or periodic maintenance of this equipment should be suitably skilled or instructed and supervised using a safe system of work. Isolate the treater before removing guards for maintenance.





EXPOSURE CONTROL

Always use caution and common sense when working with chemicals. Read the product label and SDS carefully and follow their instructions exactly as described. The following Personal Protective Equipment (PPE) recommendations and best practices help promote safe use in seed treatment.



Note: Exposure Control signs and labels conform to the requirements of ANSI Z535.4 or ISO 3864.



Wear protective clothing

Wear disposable or reusable coveralls with long sleeves.



Hand protection required

Wear chemical-resistant gloves.



Wear rubber boots

Wear chemical resistant rubber boots.



Labels

Label recommendations and directions for handling must be followed, including treatment procedure (use of sticker) as well as the safety requirements.



Treatment products

Keep products in a locked room that has been approved for crop protection products.



Wear a mask

Wear respiratory protection.



Eye protection required

Wear protective eyewear.



Calibration

Seed treatment equipment must be checked and calibrated regularly to ensure accurate and safe application.

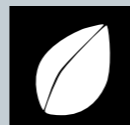

Clean seed

Use well cleaned seed to avoid creation of polluted dust that will contaminate the machine, treating facility, workers, farmers and the environment during sowing.

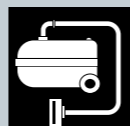

Cleaning

Use a vacuum to clean machines. Avoid using compressed air for cleaning.

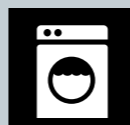

Laundry

Wash soiled reusable clothing separately. Workers must take a shower after each shift.



Empty containers

Non-returnable empty containers must be triple rinsed before they can be disposed. For others the recommendation of the producer must be followed.



Spillage

Spillage must be avoided; it must be thoroughly cleaned up to avoid contaminating the environment and waterways.



Maintenance

Keep machinery clean between treating sessions.





REFERENCE SYMBOLS

Symbols and signal words are used to identify the level of hazard and help avoid personal injury.



Note: Safety signs and labels conform to the requirements of ANSI Z535.4 or ISO 3864.



Shock Hazard

Alerts that dangerous voltage may be present.



Warning

Alerts that a hazard may cause serious injury or death.



Caution

Alerts that a hazard may cause minor or moderate injury.



Hand crush - moving parts

Alerts crushing is possible.



Pinch point

Keep hands away from pinch points.



Rotating shaft

Do not wear loose clothing around turning parts.



Disconnect

Disconnect to de-energize before opening.



Use guards

Keep guards in place. Do not remove during operation.



Lifting

Requires two people to safely lift an item.



Lift points

Requires the use of proper rigging and lifting techniques based on the lift plan.



Center of gravity

Indicates the center of gravity of the machine to help assist when rigging and lifting.



Tools

Required tools for installation and maintenance.



Parts

Required parts for installation and maintenance.



Tip

Calls attention to special information.



Note

Emphasizes general information worthy of attention.



Example

Provides a problem or exercise that illustrates a method or principle.





PICTOGRAMS

i

Each Signifier displayed here is specific to this User Manual.

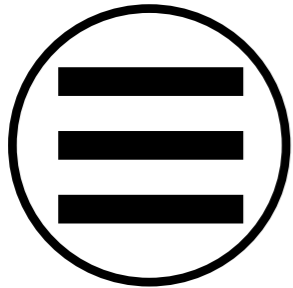

Menu



Previous



Advance



System



Installation

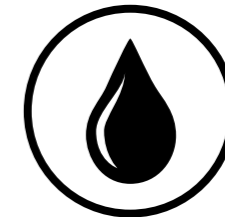

Calibration



Operation

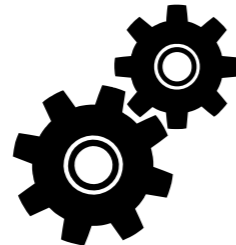

Maintenance

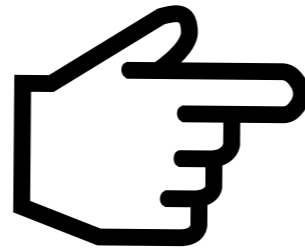

Cursor Hand



Like





SYSTEM DIAGRAM

BASIC FLOW METER ASSEMBLY, REF.

Dry Weight
14.94 LBS

Service Required
115V

4-Pump Display:
supports up to 4 flow meters



Designed to be used with an RH Basic seed treating system.

The 4-Pump Display can be mounted directly on a Treater as shown above or installed remotely.

- 1** 4-Pump Display
- 2** User Manual
- 3** Flow Meter Assembly
- 4** Signal Cable
- 5** Installation Kit
- 6** Flow Meter
- 7** Parts Kit

Replacement Parts

80495684

4-pump display W / flow meter assembly (1)

80526784

Flow meter assembly: add-on

80568142

Replacement: 4-pump display

80488459

Replacement: flow meter only with fittings

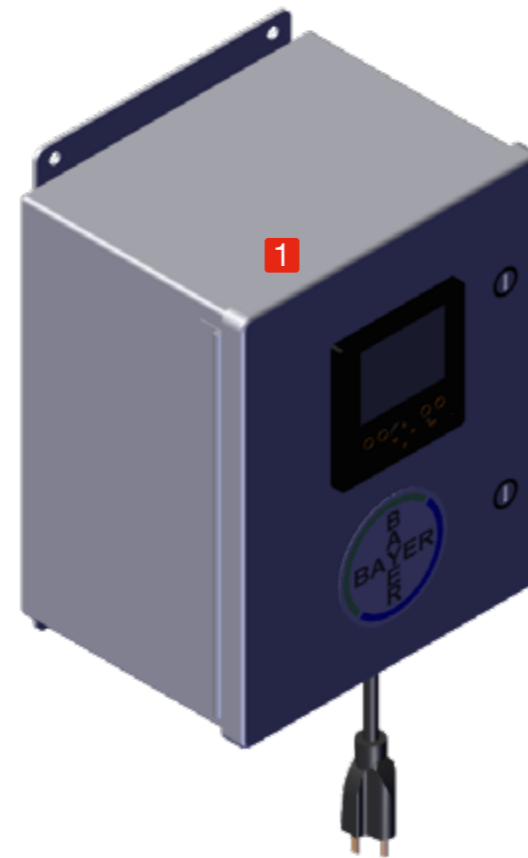

Note: hardware and tubing included in Flow meter Kit

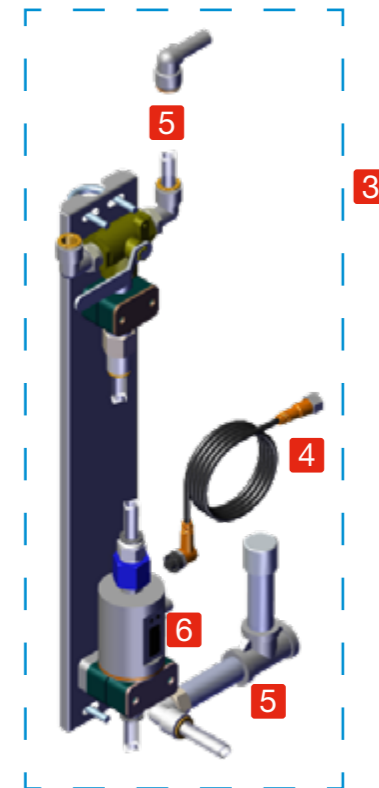



INSTALLATION



Tip: remove all components and check for any damage that may have occurred during shipping. Report any damage IMMEDIATELY!

Flow Meter Kit Box 1

- 4-Pump Digital Display
- Flow Meter Assembly
- Flow Meter Parts Kit
- Hardware Kit*
- Signal Cable
- Tubing
- Operations Manual

Mounting Hardware Kit

- 1/4-20 bolt (4)
- 1/4-20 lock-nut (4)
- 1/4 washer (4)





Flow Meter installed on old style 3-piece RH 4-pump control, ref.

4-Pump Digital Display

The 4-Pump Digital Display will fit on an old or new style RH Basic Control Mount Plate.

- Mount the 4-Pump Digital Display within close proximity to the RH Basic Machine and CBP supply tanks.

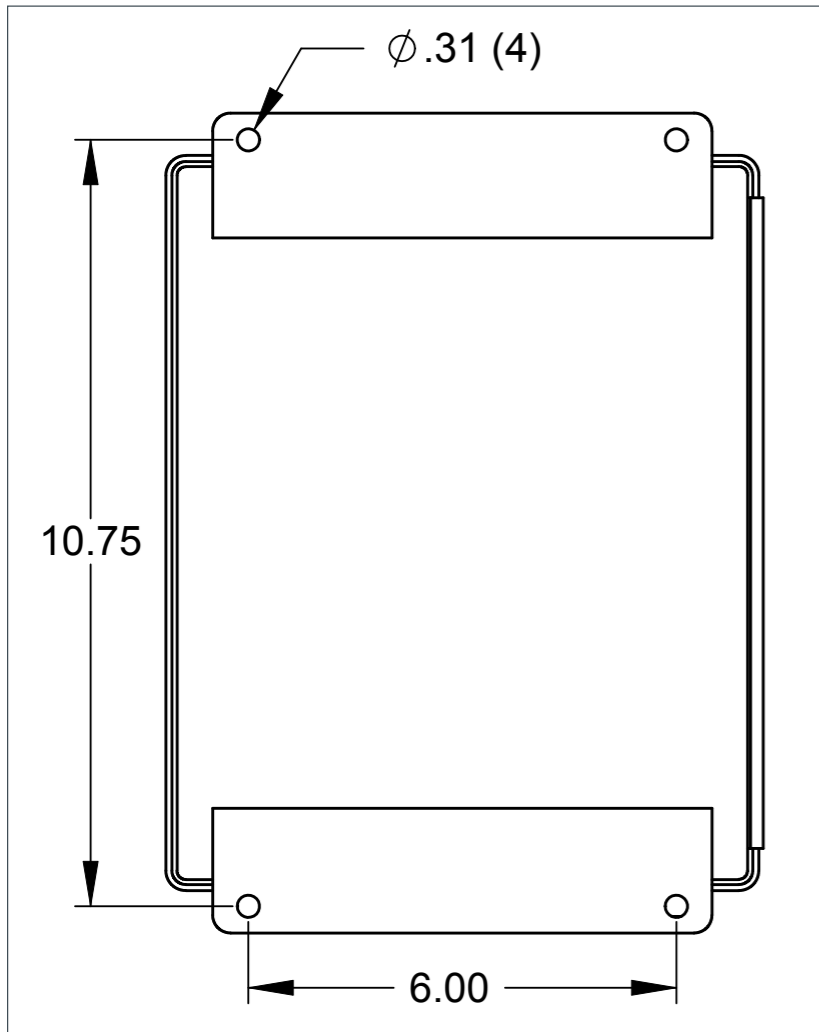

Required installation tools

- Hand Drill (1)
- 5/16" Drill Bit (1)
- Pencil or Marking Device



Remote 4-Pump Display Mounting

Use the template drawing supplied with the kit to mount the 4-Pump Display in a remote place, as follows.

Step 1: Score each hole and drill four 5/16" holes. Pre-drilled foot pattern holes are 6.00 x 10.75" on center.

Step 2: Align the 4-Pump Display over the four holes and fasten in place with 1/4-20" hardware* in the following order: 4 each bolt+flat washer+[frame]+wiz nut. Use two 7/16" wrenches and securely tighten

4-Pump Display Mount on RH Machine

Step 1: Align the top two pre-drilled bolt holes on the 4-Pump Display with the two holes directly beneath the 4-Pump Control already mounted in place on the RH Basic Machine

Step 2: Fasten the 4-Pump Display to the Mount Plate with 1/4-20" hardware* in the following order: 4 each bolt+flat washer+[frame]+wiz nut. Use two 7/16" wrenches and securely tighten.

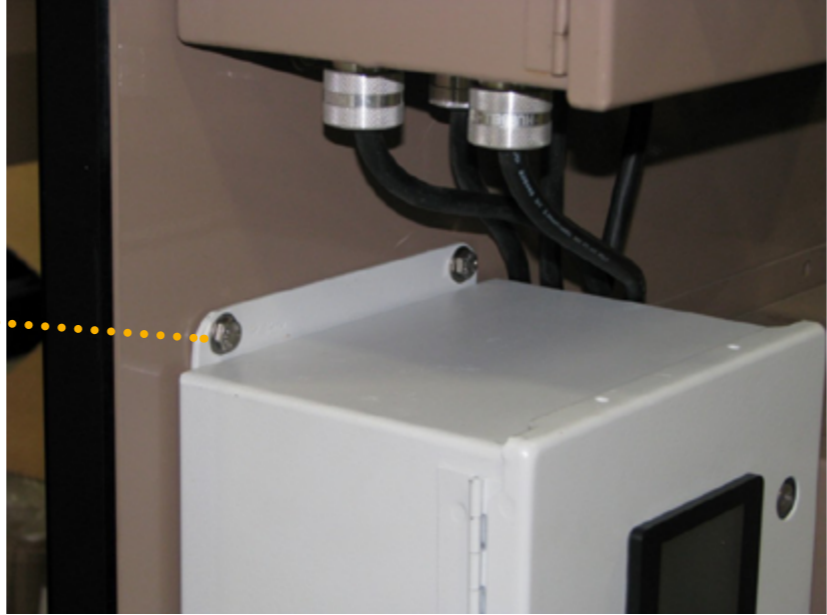
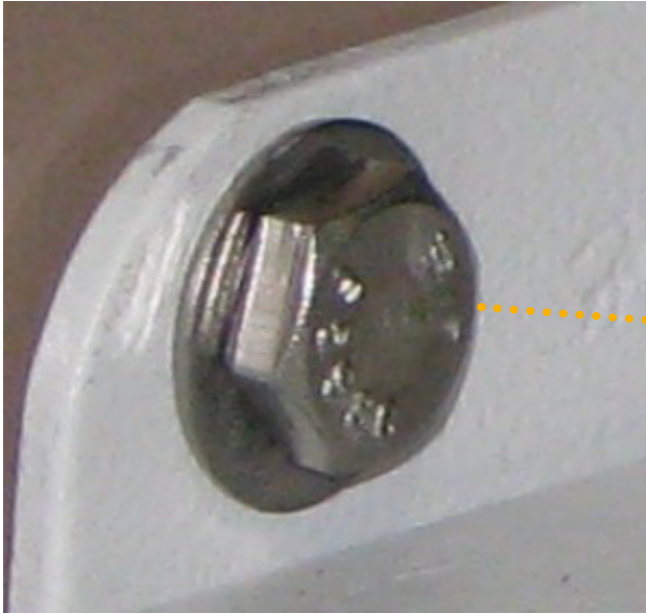

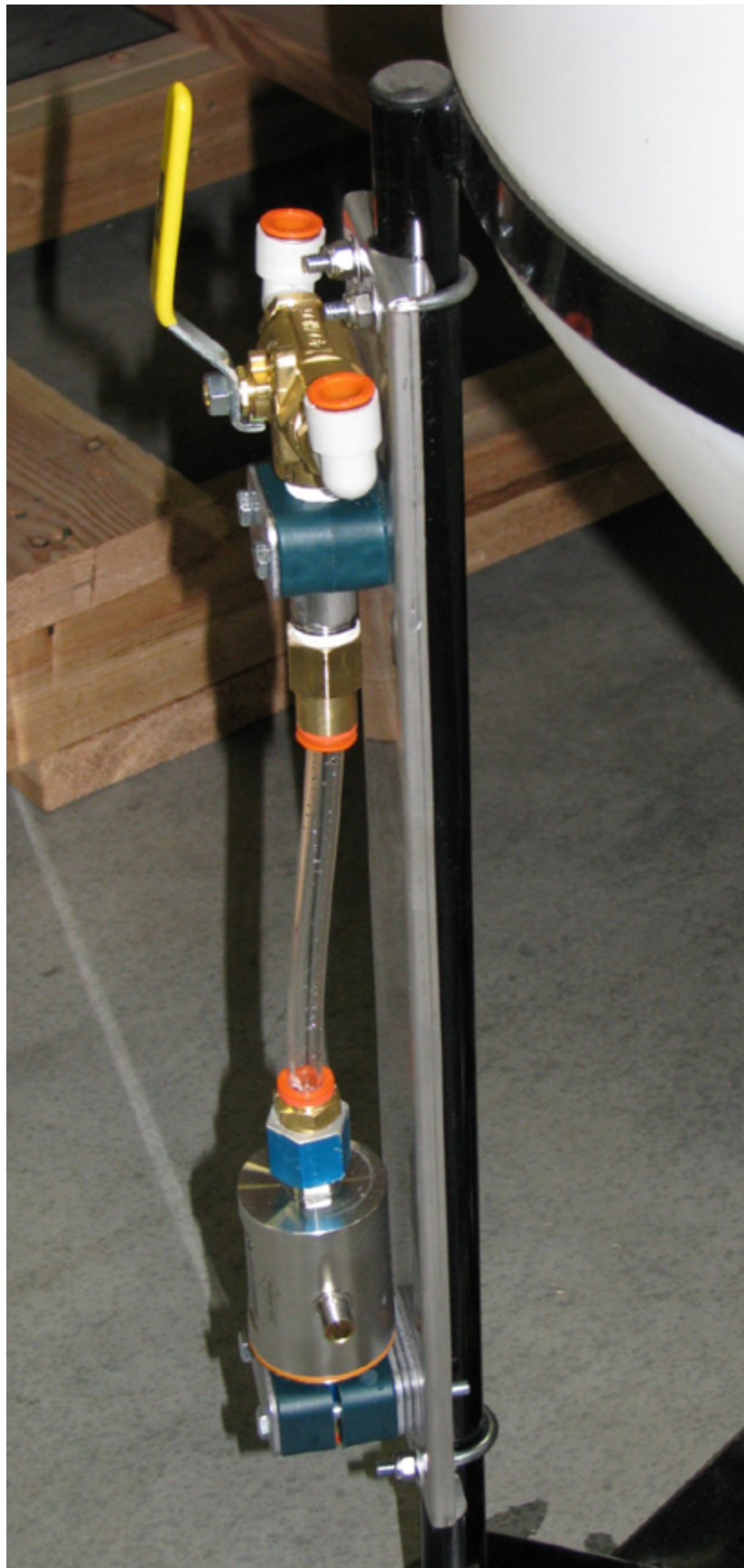

Required installation tools

- 7/16" Wrench (1)
- Hose Cutter (1)
- Anti-Seize Product



Flow Meter Assembly Mount on CBP Tank Stand

The Flow Meter Kit ships from the factory in a separate box from the 4-pump display.

- Remove from packaging and locate the Flow Meter Assembly to the CBP Tank Stand.

Continued ➔





Step 1: Insert the U-bolt from behind the Tank Stand Frame and push through the Mount Plate.

- Use a 7/16" wrench and fasten in place in the following order: U-bolt+[Frame+Mount Plate]+washer+lock nut.
- Securely tighten.
- Repeat on other end of Flow Meter Assembly.

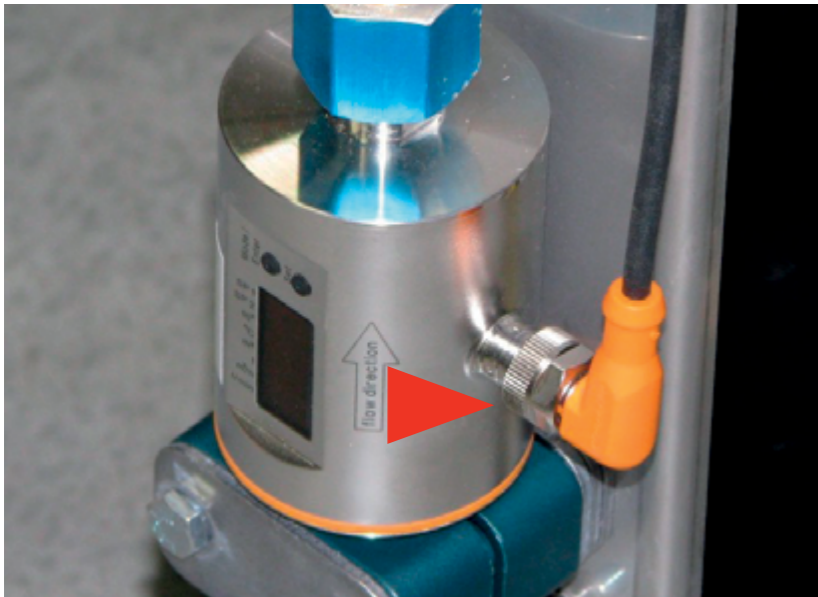

Step 2: Connect the signal cable to the bottom of Flow Meter Assembly.

- Carefully insert pin into the receptacle and screw the shield tight.



Step 3: Connect the other end of the signal cable to bottom of 4-Pump Display Box.

Continued ➔



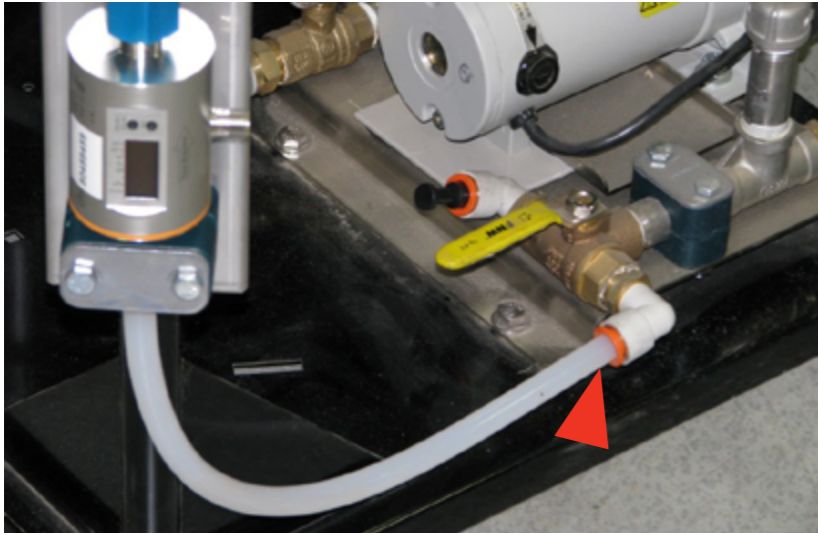

Step 4: Connect one end of the Transfer Tube to the 1/2" Press-lock Fitting on the pump, located underneath the CBP Tank.

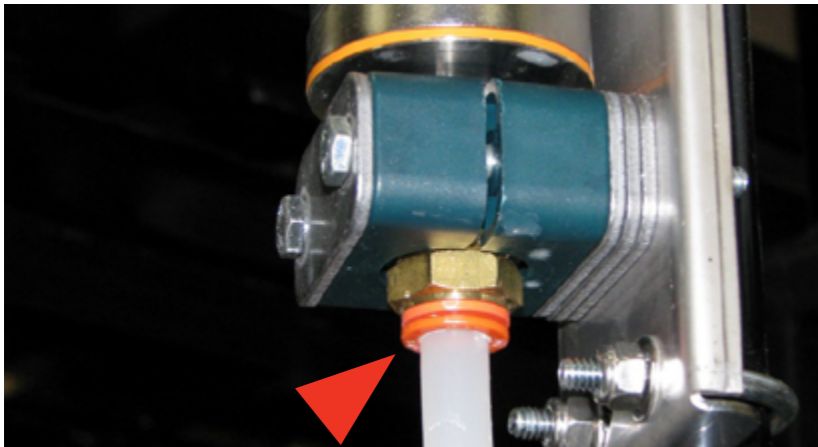

Step 5: Cut to fit and connect the other end of the Transfer Tube to the 1/2" Press-lock Fitting underneath the Flow Meter.



Step 6: Connect one end of the factory supplied Recirculation Tube to the 1/2" Male Run Tee located underneath the Calibration Tube.

Continued ➞



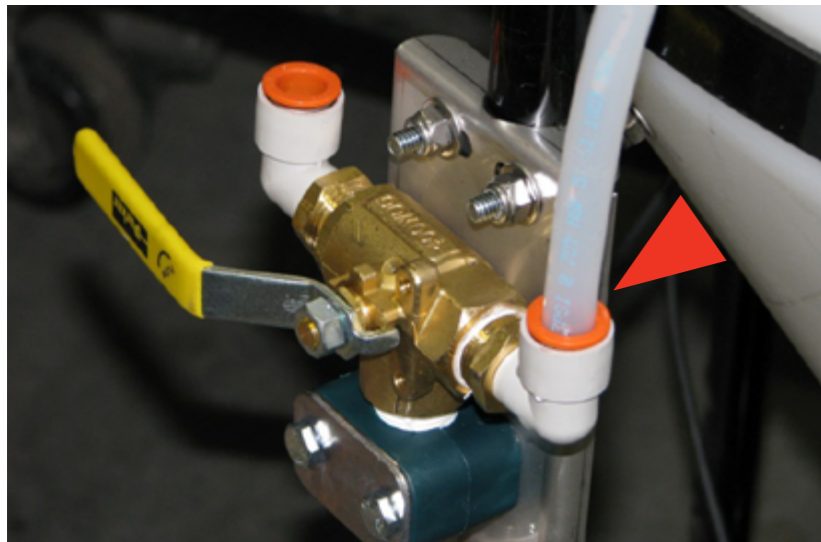

Step 7: Connect the other end of the Recirculation Tube to the 1/2" Press-lock Fitting on the Flow Meter Assembly (right side).

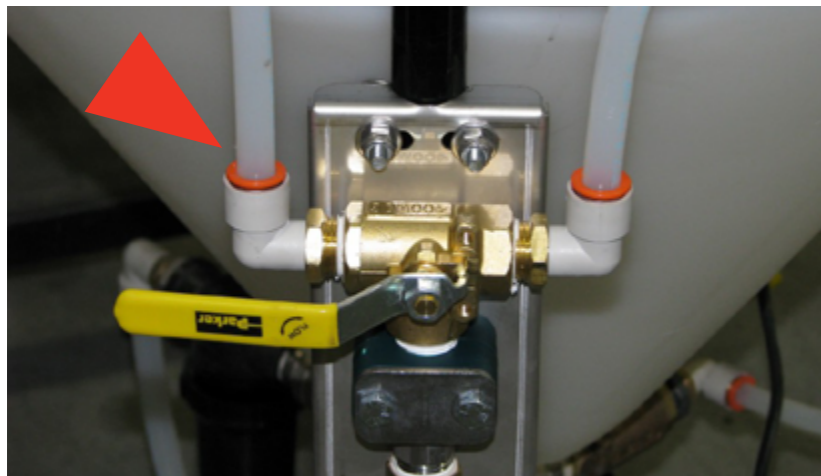

Step 8: Connect one end of the Treatment Tube to the 1/2" Press-lock Fitting on the Flow Meter Assembly (left side).



Step 9: Insert the other end of Tubing into the Treater Chemical Inlet Assembly Press Lock Fitting.

- Repeat installation for each Supply Tank (1-4) used with the system.

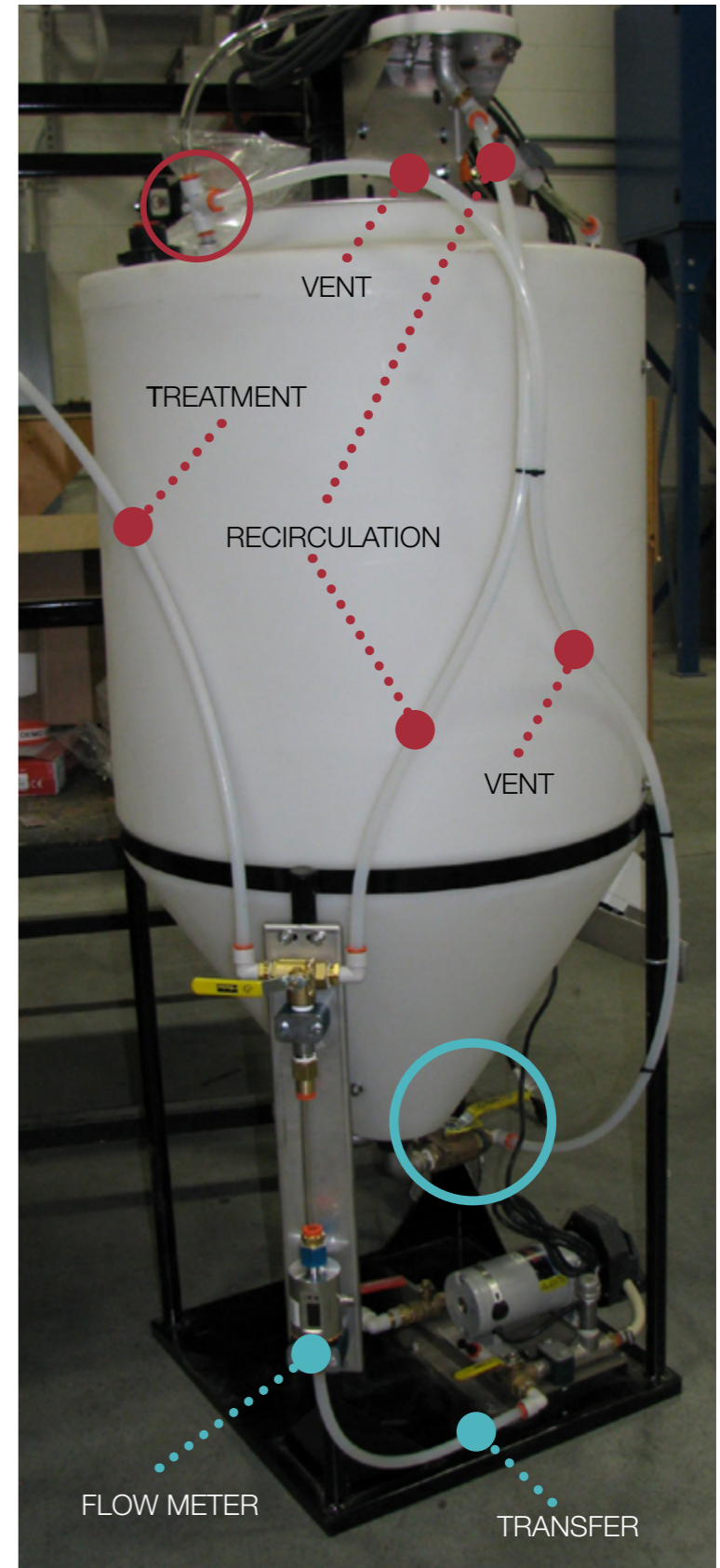

Flow Meter installed on CBP Tank, ref.



CALIBRATION



Warning! Wear proper personal protective equipment when working with chemicals: long sleeves, chemical resistant gloves and a face respirator >>



RH Basic Control + LS Pump + Closed Calibration

Step 1: Connect the Tank Agitation Power Cord to an external 115VAC power source. Tank agitation begins when power cord is plugged into power source. Ensure the Tank Valves are in the **CLOSED** position.

Step 2: Open the Tank Cover Lid and pour in desired chemicals. Allow chemicals to agitate for a few minutes.

Continued ➡

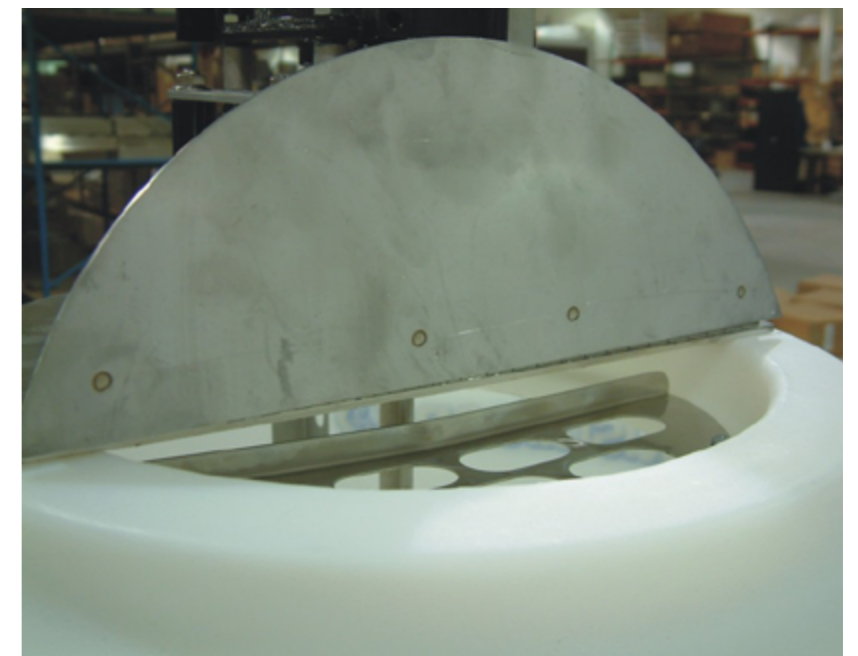
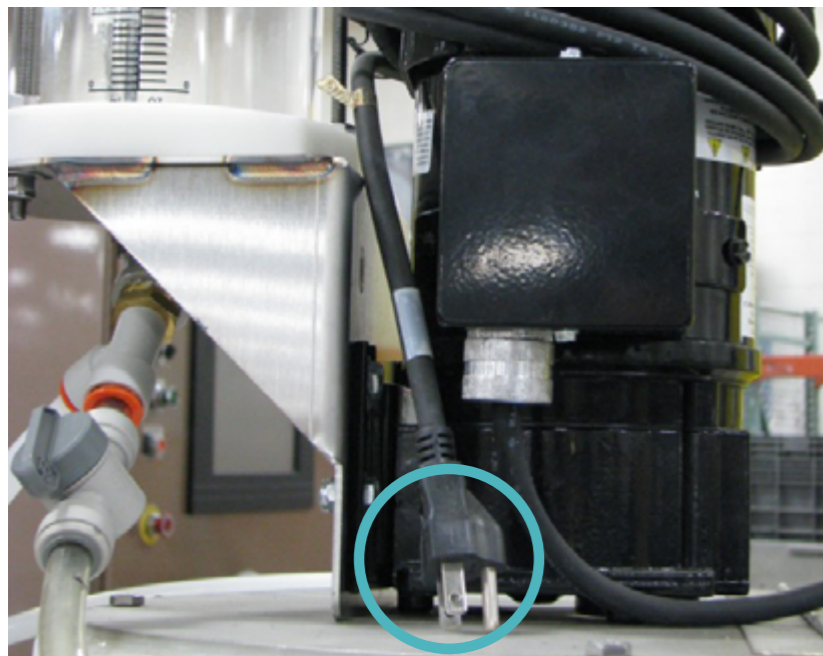

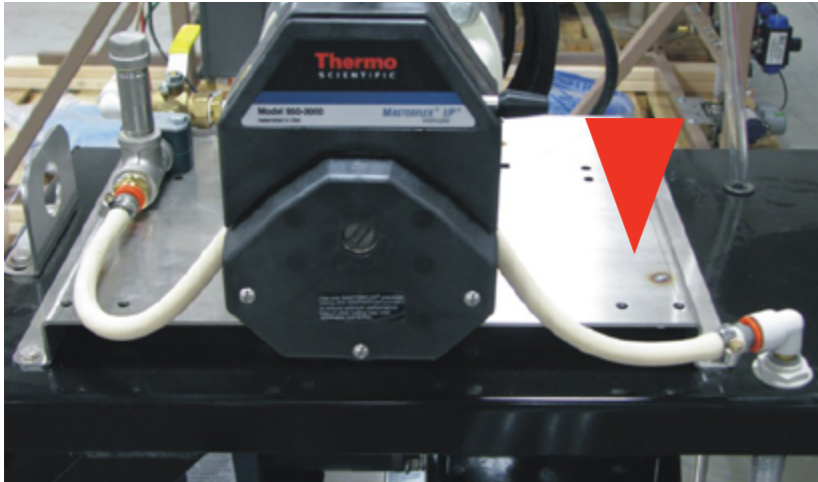

Step 3: Ensure the Pump Head is clamped **DOWN** onto the Pump Element.



Step 4: Ensure the Main Flow Valve underneath the CBP Tank from the Filter is in the **TREAT** mode.

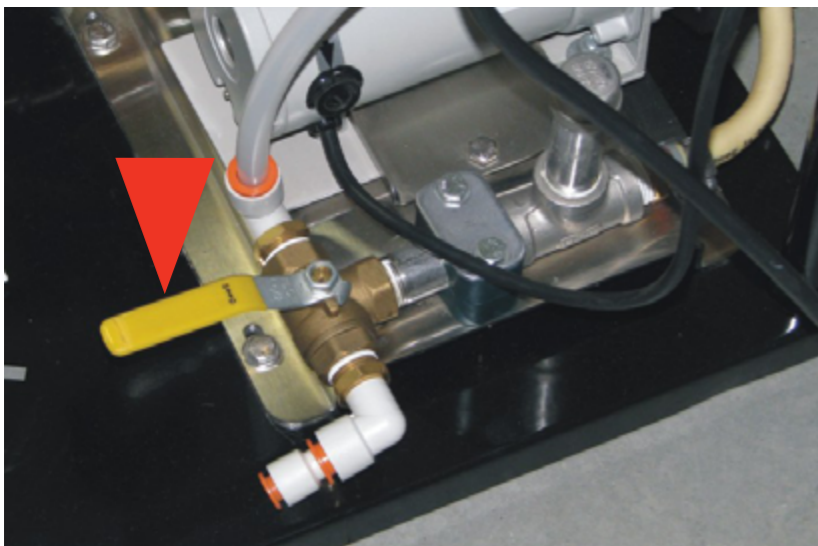

Step 5: Ensure the Recirculation Valve is in the **RECIRCULATION** mode.

Continued ➞





Step 6: Turn the Tank Valves are in the **TREAT** mode.



Step 7: Turn the LS Control Pump Switch to **FORWARD**.



Step 8: Ensure the RH Basic Main Power Switch is in the **ON** position (**UP**).

- Power light will also indicate that the power is **ON** when lit. .

Continued ➞



PUMP 1



Step 9: Turn the RH Basic PUMP #1 Switch to the **PRIME** position.

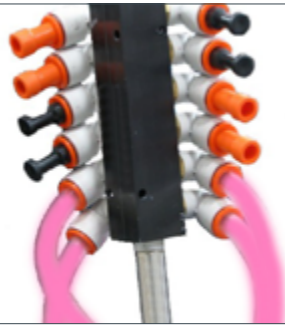

Step 10: The Pump will run, purging the treatment lines of air and send chemical to the Treater Chemical Inlet Assembly.

PUMP 1



Step 11: Then turn PUMP #1 Switch to **OFF** position.

- Repeat for all Pumps used (1-4).

Continued ➞



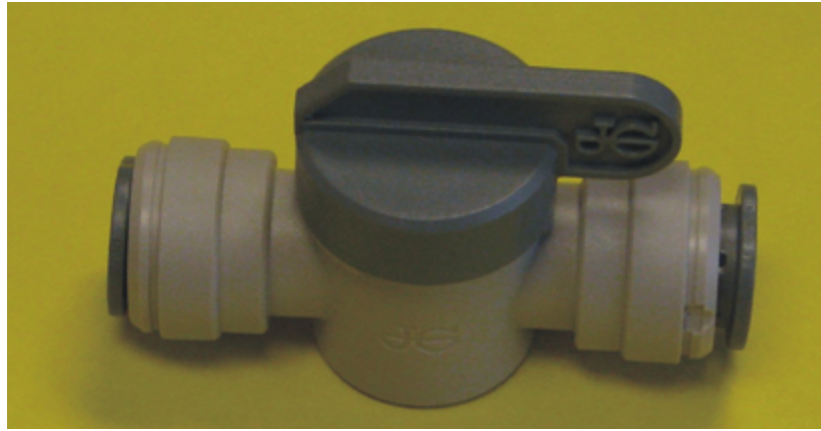

Step 12: Open the calibration drain valve, turn to right to stop recirculation back into tank.



Step 13: Turn the RH Basic PUMP #1 Switch to the **PRIME** position.

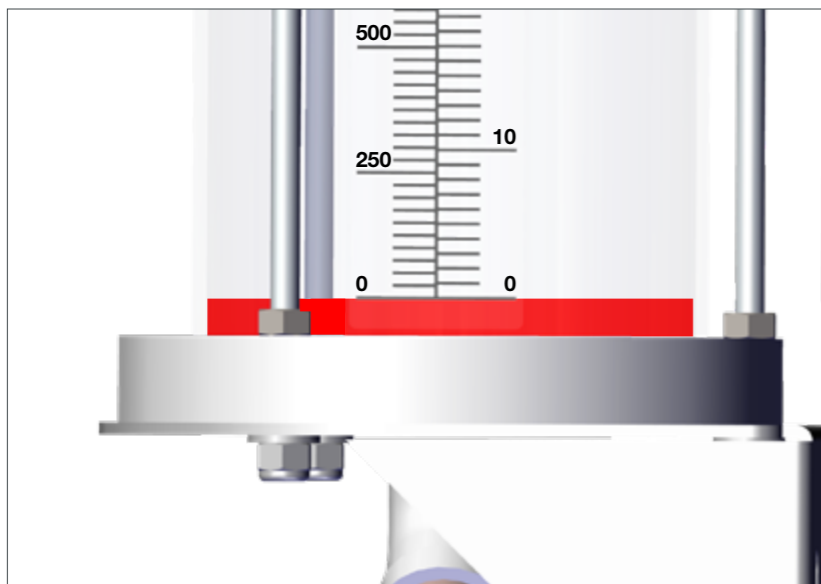

Step 14: The Pump will run, filling the Calibration Graduated Beaker with chemical just up to the **ZERO** mark.

Continued ➡





Step 15: Turn the RH Basic PUMP #1 Switch to **OFF** position.



Step 16: Hold the Pump 1 Reset button for **3** seconds: the value will display 0.0.



Step 17: Turn the RH Basic PUMP #1 Switch to the **PRIME** position.

Continued ➔



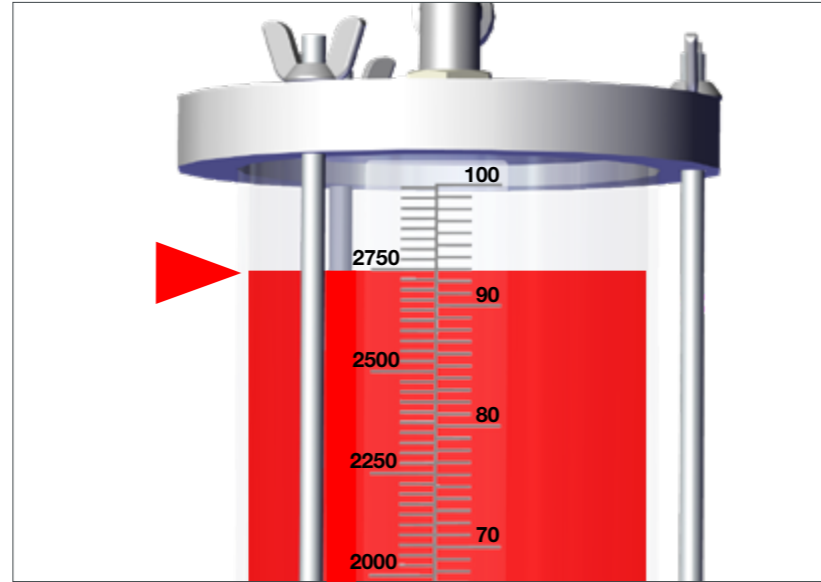
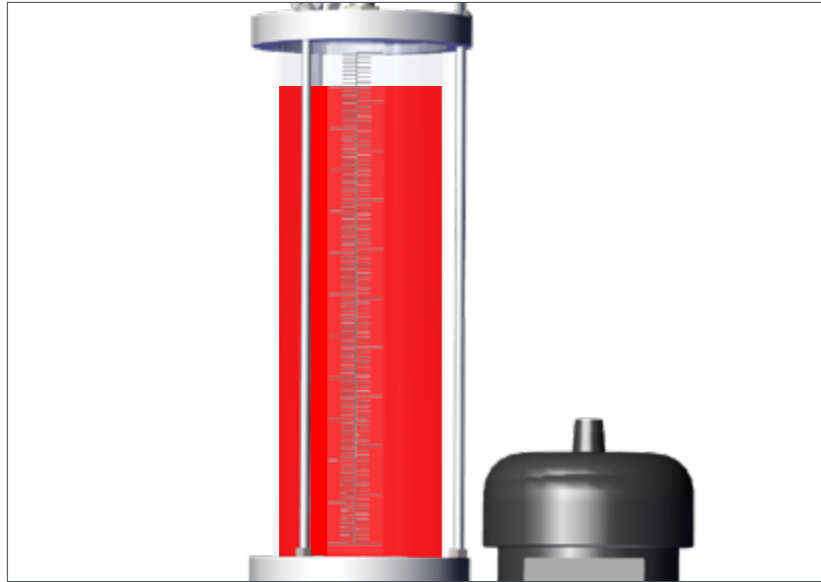

Step 18: The Pump will run, filling the Calibration Graduated Beaker with chemical for one minute.



Step 19: Turn the RH Basic PUMP #1 Switch to **OFF** position.

- Ensure chemical does not drain from the graduated cylinder!
- If required, open and close the Drain Valve to ensure the Valve properly seals!



Note: Refer to the Treatment Product Label on the chemical jug for the regulated application rate. Follow the direction exactly as stated on the label!

Continued ➡





Example: if the required application rate is 10 ounces (296ml) of treatment per hundredweight (cwt) of seed (60lbs in 1 minute), the desired amount of treatment that needs to fill the calibration beaker in 1 minute would be 177.6ml...

$$296\text{ml} \div 100\text{cwt} = 2.96\text{ml} \times 60\text{lbs} = 177.6$$



Note: Speed Indicator sets the speed of the pump. The higher the number, the faster the speed of the pump... Turn dial right or left.

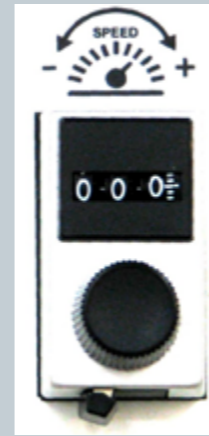

$$296\text{ml} \div 100\text{cwt} = 2.96\text{ml} \times 60\text{lbs} = 177.6$$

Multiple calibration runs may need to be made by adjusting the LS pump speed, until the desired amount of chemical pumped reaches the target amount.

The calibration process will need to be repeated whenever a new seed type or seed size is introduced into the treating process.

Changes beyond the control of the operator or the functionality of the machine, such as temperature, humidity and wind speed throughout the day, can affect the calibration.



It is highly recommended that calibration checks be made periodically throughout the day, to help ensure proper application rates are achieved.

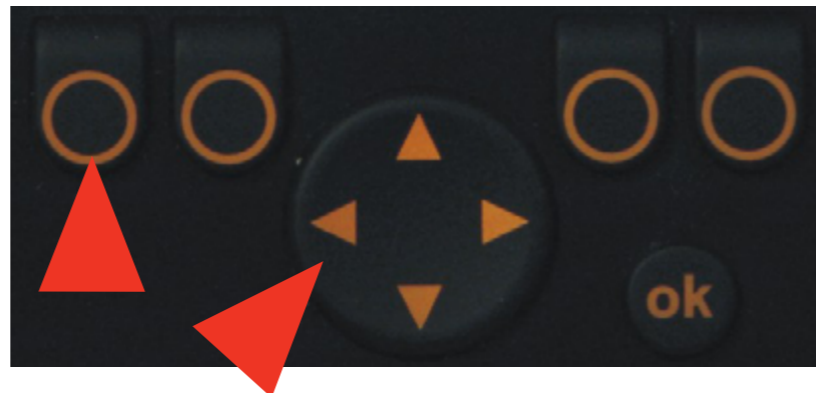
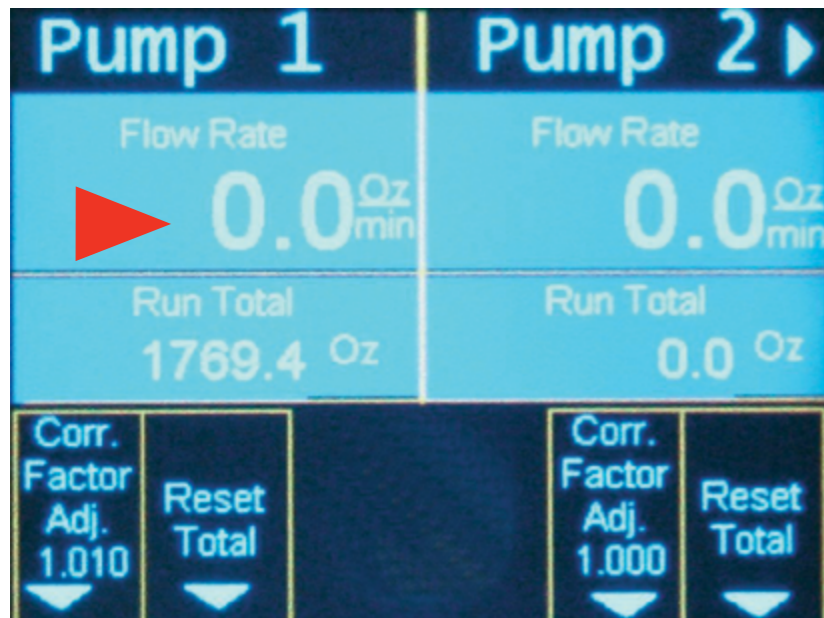

Step 20: Hold the Pump 1 Correction factor button and use the up/down arrow to adjust the correction factor and the run total until the total matches the amount captured in the beaker.

- Once the run total matches the Beaker amount, the Pump calibration is complete.

Continued ➔



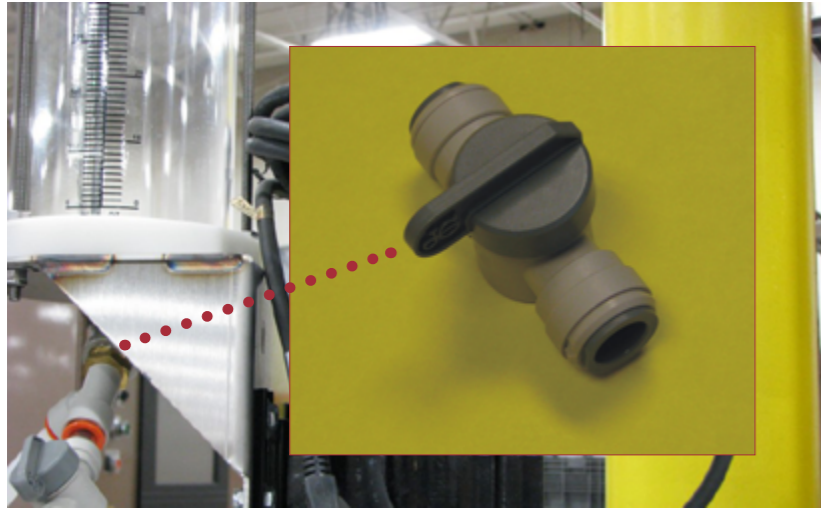

Step 21: Turn the Drain Valve underneath the calibration Tube to the right.

- Chemical will drain from the Beaker back into the Supply Tank.
- Repeat these calibration steps for each Supply Tank used until desired calibration results are achieved.

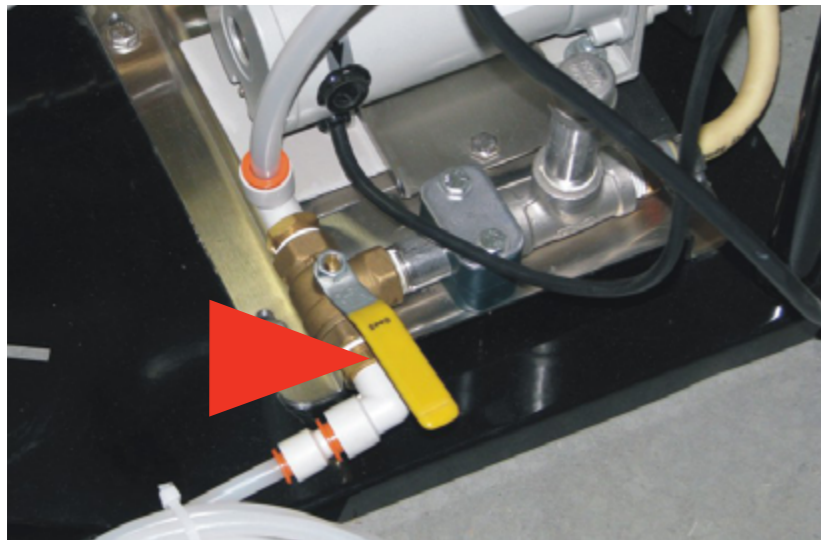

Step 22: When calibration is complete, turn the Recirculation Valve in the **TREAT** mode.

Continued ➞



Note:
Check pump calibration on each lot of seed.
If extremely high or low temperatures exist, the viscosity and flow of certain treatment products may be affected.
A typical example would be treating early in the morning at colder temperatures compared to treating in the afternoon when the temperature has increased.





Step 23: Turn the RH Basic PUMP #1 Switch to the **PRIME** position.



Step 24: The Pump will run, purging the treatment lines of air and send chemical to the Treater Chemical Inlet Assembly.



Step 25: Then turn PUMP #1 Switch to **OFF** position.

- Repeat for all Pumps used (1-4).





OPERATION



Note: The Flow Meter Kit is designed to be used in conjunction with the RH Basic Seed Treating System.

The flow meter digitally displays the current chemical flow rate of each Pump (1-4) used underneath each CBP supply tank.

For best accuracy: Calibrate at/near the flow rate required for optimal treating: $(1500\text{lb}/\text{min})/100 \times 2\text{oz}/\text{cwt}^* = 30\text{oz}/\text{min}$.

*cwt=per hundred weight of seed

THEORY OF OPERATION

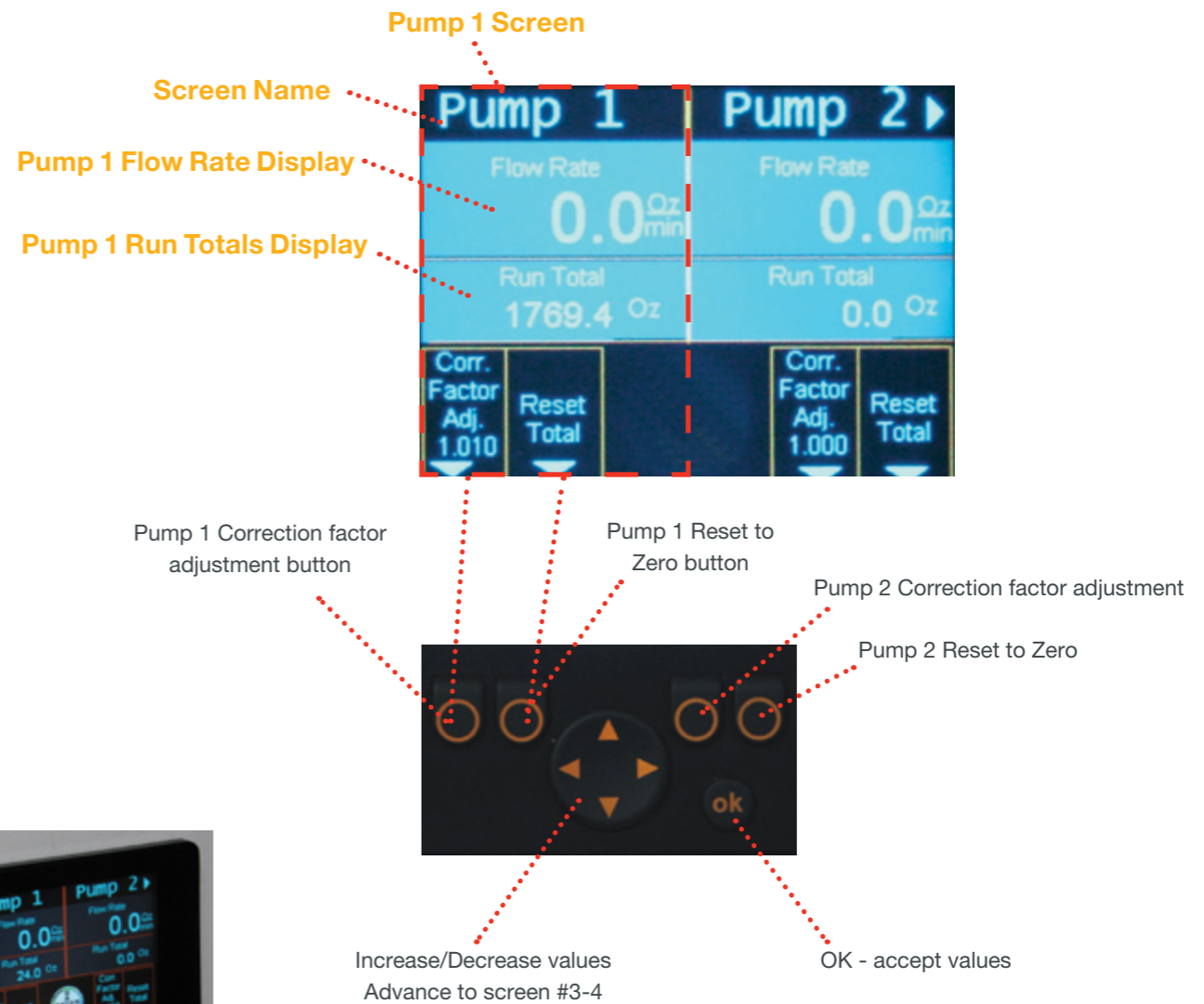

To toggle between Empirical and metric units, hold the DOWN arrow for 5 seconds and release. Hold down again to switch back.





MAINTENANCE



Warning! Wear proper personal protective equipment when working with chemicals: long sleeves, chemical resistant gloves and a face respirator >>



Clean the Flow Meter

Step 1: Remove the Transfer Tube from the 1/2" Press-lock Fitting underneath the Flow Meter.

Step 2: Hardware Kit marked A408160PK / 80027796 has two brushes. Insert a brush up into the bottom of the flow meter and thoroughly clean the flow meter. Clean the brush responsibly.

Step 3: Replace the Transfer Tube in the 1/2" Press-lock Fitting underneath the Flow Meter.

Continued ➞

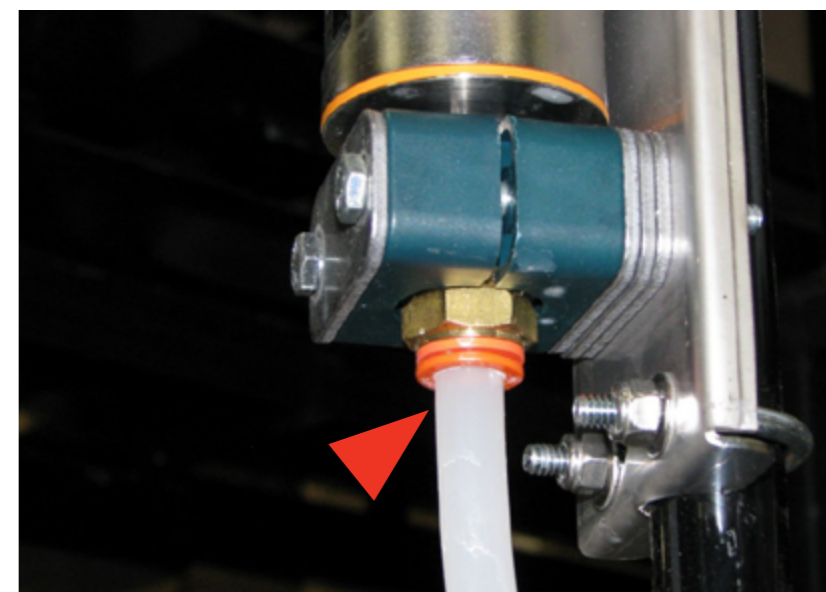
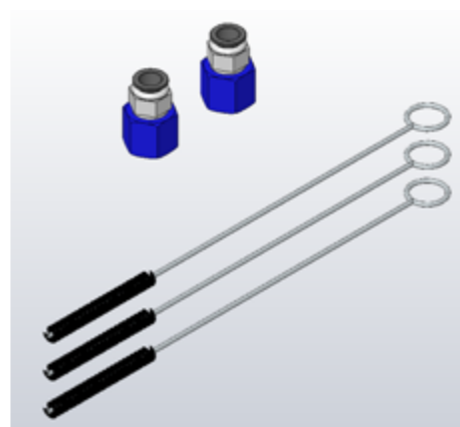
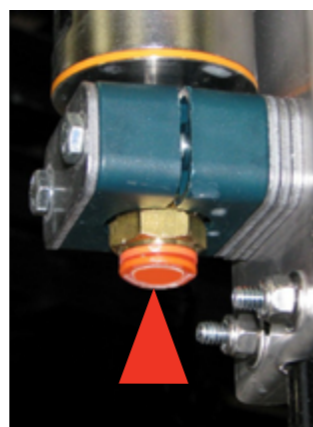
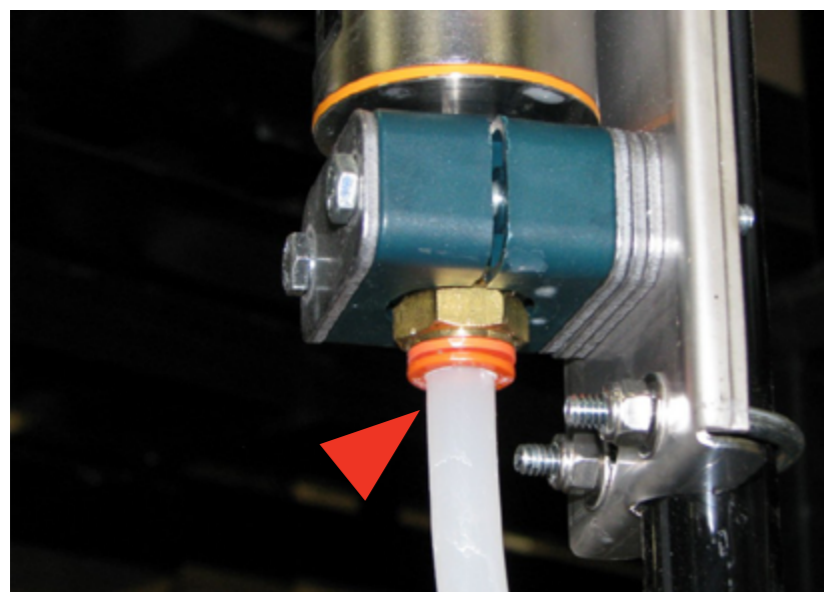

Replace Flow Meter Fittings

Step 1: Hardware Kit marked A408160PK / 80027796 has two fittings that can be replaced on top of the flow meter.

- Remove the tube from the fitting.
- Use a wrench to loosen each nut (if both need replacing).

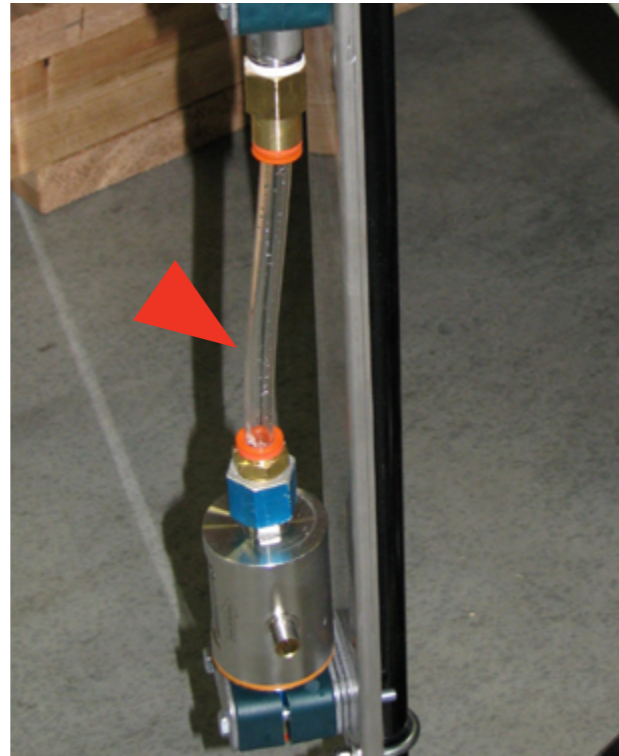
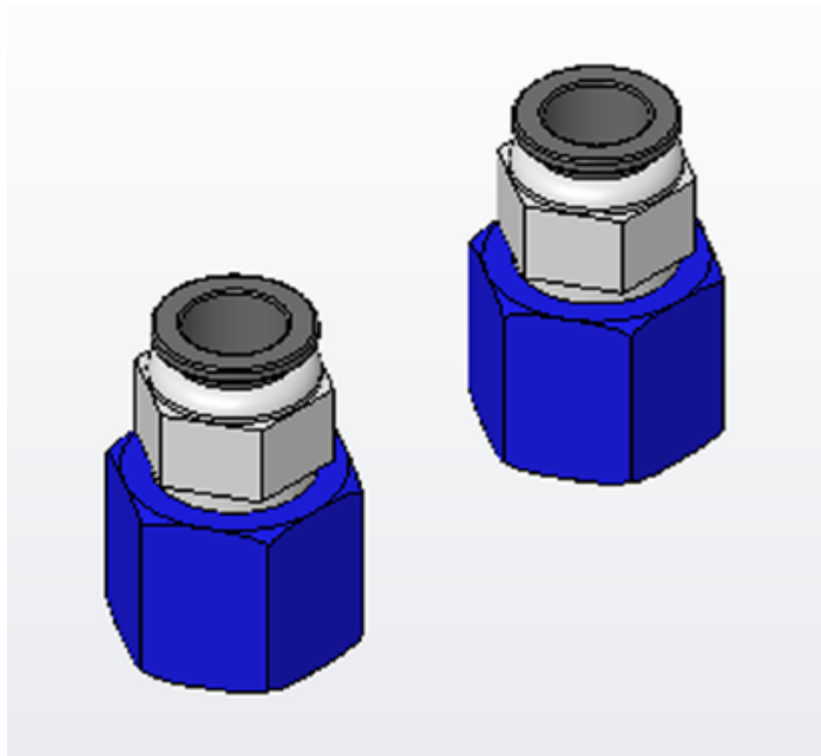

Required installation tools

- Crescent Wrench (1)

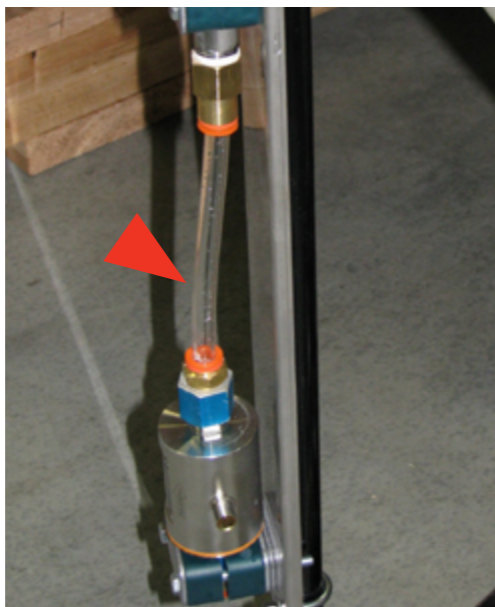

Step 2: Remove the fitting(s) and replace with new one.

- Tighten new nut securely in place.
- Reconnect the tube into the fitting.





Bayer

Crop Science Division
1451 Dean Lakes Trail
Shakopee, MN 5379
USA

Telephone

+1-952-445-6868

Toll free:

+1-855-363-3152

Visit us on:

www.seedgrowth.bayer.com

Bayer™ and the Bayer Cross™ are registered trademarks of Bayer.

FLOWMETERKIT20211022

